



# eMobility solutions

Building the future of all-electric mobility

Electric vehicle charging solutions

Catalog 2024

[se.com/emobility](https://se.com/emobility)

Life Is On

**Schneider**  
Electric

# Legal information

The information provided in this Catalog contains description of Schneider Electric products, solutions and services ("Offer") with technical specifications and technical characteristics of the performance of the corresponding Offer.

**The content of this document is subject to revision at any time without notice due to continued progress in methodology, design and manufacturing.**

To the extent permitted by applicable law, no responsibility or liability is assumed by Schneider Electric and its subsidiaries for any type of damages arising out of or in connection with (i) informational content of this Catalog not conforming with or exceeding the technical specifications, or (ii) any error contained in this Catalog, or (iii) any use, decision, act or omission made or taken on basis of or in reliance on any information contained or referred to in this Catalog.

**SCHNEIDER ELECTRIC MAKES NO WARRANTY OR REPRESENTATION OF ANY KIND, WHETHER EXPRESS OR IMPLIED, AS TO WHETHER THIS CATALOG OR ANY INFORMATION CONTAINED THEREIN SUCH AS PRODUCTS AND SERVICES WILL MEET REQUIREMENTS, EXPECTATIONS OR PURPOSE OF ANY PERSON MAKING USE THEREOF.**

Schneider Electric brand and any trademarks of Schneider Electric and its subsidiaries referred to in this Catalog are property of Schneider Electric or its subsidiaries. All other brands are trademarks of their respective owners.

This Catalog and its content are protected under applicable copyright laws and provided for informative use only. No part of this Catalog may be reproduced or transmitted in any form or by any means (electronic, mechanical, photocopying, recording, or otherwise), for any purpose, without the prior written permission of Schneider Electric.

Copyright, intellectual, and all other proprietary rights in the content of this Catalog (including but not limited to software, audio, video, text, and photographs) rests with Schneider Electric or its licensors. All rights in content not expressly granted herein are reserved. No rights of any kind are licensed or assigned or shall otherwise pass to persons accessing this information.





# Green Premium™

Schneider Electric's commitment to deliver sustainable performance, by design.



More than 75% of our product sales offer superior transparency on the material content, regulatory information and environmental impact of our products:

- RoHS compliance
- REACH substance information
- Industry leading # of PEP's\*
- Circularity instructions



Learn more about  
**Green Premium**

Green Premium label promises compliance with the latest regulations, transparency on environmental impacts as well as circular and low-CO<sub>2</sub> products.

#### CO<sub>2</sub> and P&L impact through... Resource Performance

Green Premium brings improved resource efficiency throughout an asset's lifecycle. This includes efficient use of energy and natural resources, along with the minimization of CO<sub>2</sub> emissions.

#### Cost of ownership optimization through... Circular Performance

We're helping our customers optimize the total cost of ownership of their assets. To do this, we provide IoT-enabled solutions, as well as upgrade, repair, retrofit, and remanufacture services.

#### Peace of mind through... Well-being Performance

Green Premium products are RoHS and REACH compliant. We're going beyond regulatory compliance with step-by-step substitution of certain materials and substances from our products.

#### Improved sales through... Differentiation

Green Premium delivers strong value propositions through third-party labels and services. By collaborating with third-party organizations we can support our customers in meeting their sustainability goals such as green building certifications.

\*PEP: Product Environmental Profile (i.e. Environmental Product Declaration)



# Contents

---

eMobility solutions .....	p. 6
eMobility for Residential Applications .....	p. 8
eMobility for Buildings Applications .....	p. 10
eMobility solutions: Panorama per Applications .....	p. 16
<b>Schneider Charge.....</b>	<b>p. 19</b>
Schneider Charge.....	p. 20
Range accessories .....	p. 22
Anti-tripping Module .....	p. 23
<b>EVlink™ Pro AC and Pro AC Metal.....</b>	<b>p. 25</b>
EVlink™ Pro AC .....	p. 26
EVlink™ Pro AC Metal.....	p. 29
Customization .....	p. 36
Range accessories and spare parts.....	p. 38
Cables for EVlink™ Home and Pro AC ranges.....	p. 40
<b>EVlink™ Pro DC .....</b>	<b>p. 43</b>
EVlink™ Pro DC 120-180 kW .....	p. 44
<b>Energy management, software and digital services .....</b>	<b>p. 49</b>
Energy management .....	p. 50
EcoStruxure™ EV Charging Expert .....	p. 52
EcoStruxure™ EV Advisor* .....	p. 56
<b>eMobility Services.....</b>	<b>p. 61</b>
eMobility Services .....	p. 62
How do I install and commission?.....	p. 63
How do I maintain? .....	p. 64
How do I optimize? .....	p. 65
A professional Network .....	p. 65
Get in touch for support.....	p. 66
Commercial references.....	p. 67
<b>Electrical Distribution for eMobility .....</b>	<b>p. 69</b>
Schneider Electric Power Distribution .....	p. 71
Acti9 Type A-SI or B: Residual Current Devices (RCD) .....	p. 72
ComPact NSX and VigiPacT add-on: Earth leakage protection .....	p. 73
iMNx: undervoltage release tripping unit .....	p. 74
Metering solutions.....	p. 75
Decentralized EV distribution: Canalis™ .....	p. 77
<b>Appendix .....</b>	<b>p. 79</b>

\*Available soon in selected European countries



# eMobility solutions



Extensive network of certified partners



Industry standards compliance



Worldwide customer support



End-to-end solutions provider

## Building the mobility of the future

SCALABILITY AND RESILIENCY  
EFFICIENCY AND SUSTAINABILITY  
CONNECTIVITY AND INTEROPERABILITY  
CYBERSECURITY

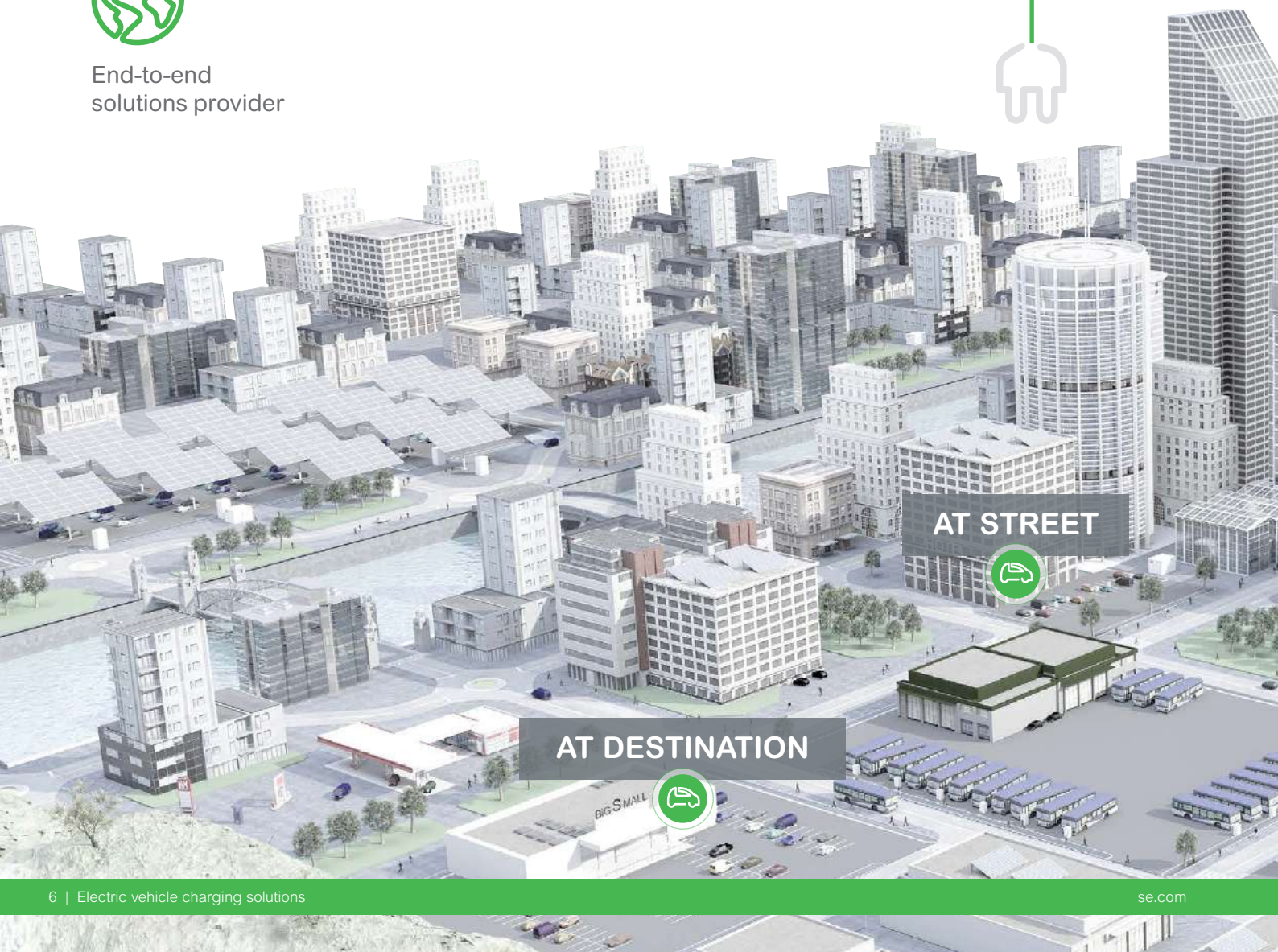

AT STREET



AT DESTINATION





We provide end-to-end eMobility solutions, beyond the EV charging infrastructure, where the whole electric mobility ecosystem is connected to provide cost-efficient and convenient charging experience for homes, buildings, and fleets, minimizing downtime and prioritizing the use of renewable energy for a net-zero future.



Homes



Buildings



AT PUBLIC



AT WORK



AT HOME



“ We drive towards a 100% electric mobility for a more efficient, resilient and sustainable way to get to a net-zero destination ”





# eMobility for Residential Applications

## Smart homes, smarter EV charging: Schneider Charge



“I want a robust end-to-end solution when installing EV charging stations that is compatible with my customer's preferred mobile application”.

Deliver your customer an attractive charging station that provides them with simple remote control of their EV charging and optimizes their energy costs without compromising their comfort.

### > Schneider Charge

#### Single family home charging station

##### Easy installation and wiring:

- Three cabling options
- Wall spacers for uneven walls
- Captive screws and metal black plate with slotted holes
- Connectors for fast and long-time wiring
- Ready for voltage and continuity test

##### Characteristics:

- T2S socket up to 22 kW, combined 1P/3P
- Up to 7.4 kW 1P or 11 kW 3P, with 5 or 7 m attached cable with T2 connector
- OCPP 1.6J
- Single push-button for configuration
- Signal connectors for iMNx, DSO (Distribution System Operators: remote control enabling the utility to suspend the charge\*) and TIC (for France only, function requested to connect Linky meter)



### > Anti-Tripping Module

#### Power load management

- Continuously adapts the charging power, taking home consumption and self-generated energy into account (PV, wind, storage...)

##### Characteristics:

- 1-phase or 3-phase products
- Power Line Communication with pairing: no need for additional cable

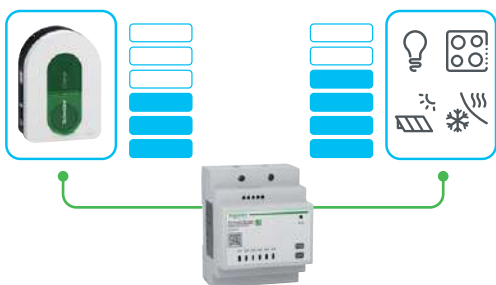

\*According to Technical Connection Rules VDE-AR-N-4100:2019-04



## ➤ Schneider Electric mobile applications

### eSetup or Wiser Home\* to commission Schneider Charge

- Firmware upgrade
- Electrical parameter settings
- Wi-Fi connection to home router
- EV charging application: Wiser pre-set



### Wiser to optimize home energy consumption, including the EV charging

- Remote control and scheduling
- Bill optimization based on Time of Use tariff
- Energy consumption and cost history

## ➤ Commission and control Schneider Charge from the palm of your hand

### Connectivity settings via eSetup

- Select or configure the 3<sup>rd</sup> party charging application (OCPP communication)
- Send information to the owner to let them finalize the connection to their EV charging application



### Monitor and control the EV charging station, and much more

- Monitoring, scheduling and cost optimization
- Plus other features depending on the application (grid services...)

\* According to your country

## Overview of the Schneider Charge - Family Home Solution

### Upgrade the electrical installation



**Schneider Charge anti-tripping module:**  
1-phase or 3-phase Peak Controller

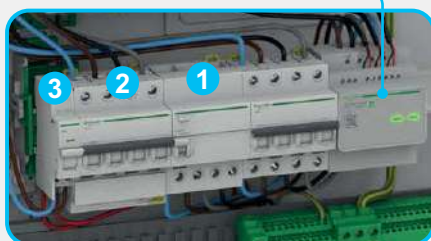

- 1 RCD Type A-SI to detect AC residual current (30 mA)
- 2 MCB to provide charging station cable overload protection
- 3 MNx: undervoltage release tripping unit (IEC 61851-1 ed.3)

Option: **RCBO** residual current breaker with overcurrent protection



Commission easily with **eSetup**

### Charge at home

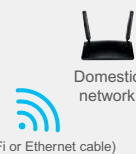

(WiFi or Ethernet cable)



**Schneider Charge**

### Select the EV charging application to optimize energy costs



Home Energy Management System



All-in-one app



Energy consumption dashboard



Charging modes selection

Power: from 7.4 to 22 kW



Or 3<sup>rd</sup> party EV charging applications



# eMobility for Buildings Applications

From a scalable to an optimized solution for tertiary sites



## EVlink Pro AC Connected EV charging stations

- Optimized usage and usability:
  - Reduced maintenance time
  - Robust design (IP55/IK10 rated) for indoor/outdoor installations
  - Customizable charging stations
- Embedded protection for power distribution (RCD; iMNx)
- RFID/NFC reader for user authentication
- Standards-compliant: precision metering (MID meters)
- Flexible and modular:
  - Interoperability with supervision solutions (OCPP 1.6-J)
  - Extended EV compatibility (IEC 61851 Ed.3, ISO 15118 upgradable)



## EVlink Pro DC Fast charging: 180 kW dual connectors

- Certified to the highest electrical standards
- Dynamic load balancing between vehicle connectors
- Robust design for outdoor or indoor installations (IP55)
- Authentication: RFID/NFC reader or auto-charge (mac address)
- Interoperability with supervisions systems (OCPP 1.6-J)
- Repairable product, Green Premium labelled
- Worldwide network providing on-site service for commissioning and maintenance

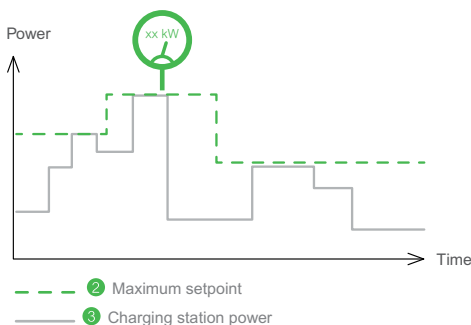

## EcoStruxure EV Charging Expert Load Management System

- Dynamic distribution of available power among charging stations
- Peak/off-peak hours EV charging management
- Monitoring and control of EV charging stations based on an open protocol (OCPP 1.6-J)



# Charging infrastructure for employees or customer's driving EVs

EcoStruxure for eMobility provides a first easy step for business owners to start up electric mobility in their companies while keeping investment, utility costs and power supply fully optimized. Improving the customer experience and satisfying employees driving an electric vehicle, all at the same time.

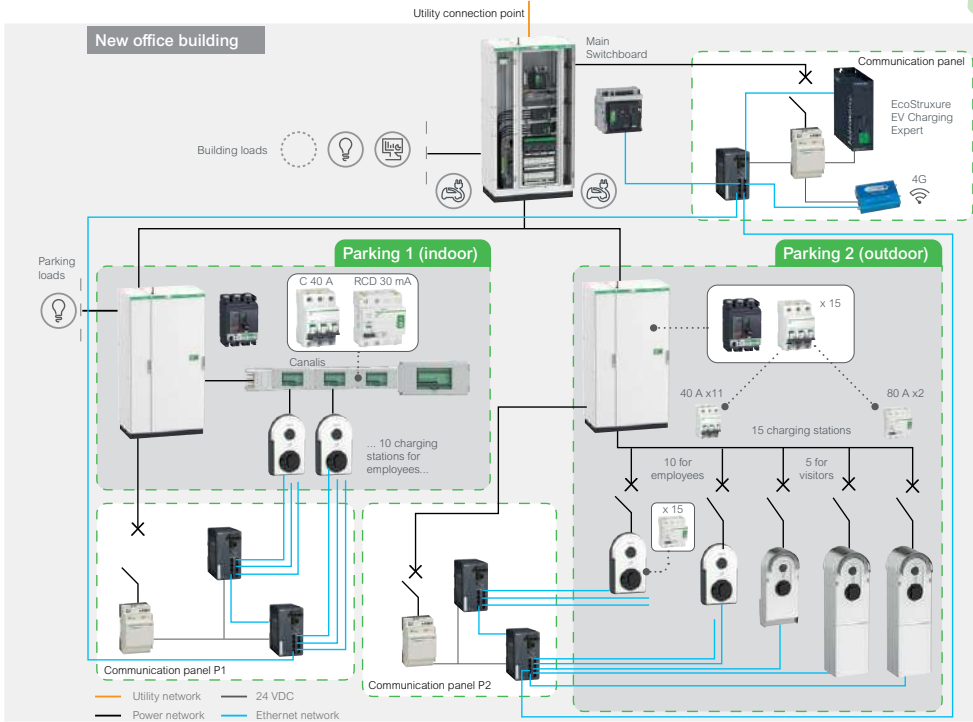
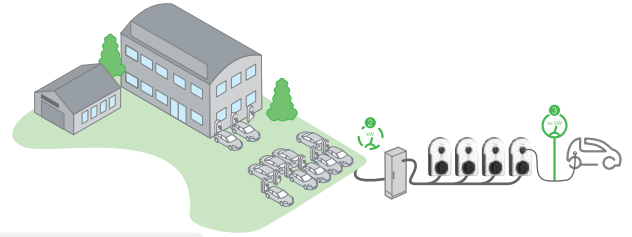

## Customer benefits



### For electrical contractors:

- Reduced installation time
- Guided commissioning
- Schneider Electric Partner certification and training program



### For building owners:

- Demonstration of sustainability commitments
- Improved employee satisfaction and customer loyalty
- Optimized power availability
- Scalable infrastructure
- In-house operations or delegated to external charge point operator

## Multi-site Applications

EcoStruxure EV Advisor our cloud-based supervision system enables building and business owners to seamlessly integrate electric mobility on all their sites. Complying with local regulations while offering a futureproof and convenient solution to serve EV drivers.

### EcoStruxure™ EV Advisor\*

#### Multi-site remote supervision for EV charging infrastructures

EcoStruxure EV Advisor covers multiple use-cases and provides a convenient solution for EV Drivers.

- Remote monitoring, control and troubleshooting
- Analytics and API capability
- Custom tariff setting and multiple methods of collecting payment
- Accessible by registered EV drivers and/or ad-hoc



Multi-site and remote supervision of all the EV infrastructure thanks to EcoStruxure™ EV Advisor

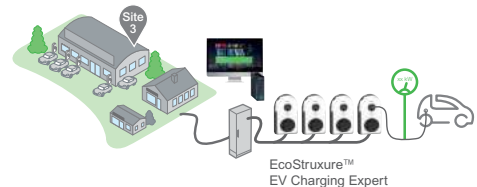
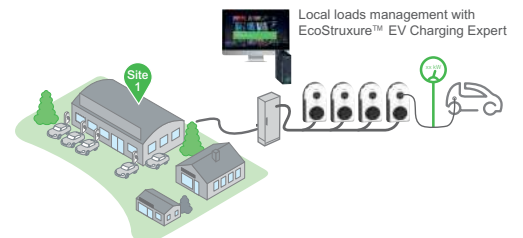

### For operators:

- Service offer: charge point availability, identification of issues

Optimized operations thanks to remote diagnosis features and shorter interventions



### For building owners:

- Minimized upfront costs
- Multiple user profiles

\*Available soon in selected European countries



# eMobility for Buildings Applications

Transition car parks or fleets to net-zero transportation



## ➤ EVlink Pro Pay payment kiosk

- Contactless payment
- Pin on glass
- VISA, Mastercard, Apple Pay, Google Pay
- Dynamic Display of pricing policy
- Color touch screen
- Manage payment for up to 10 chargers
- LAN or 4G connectivity
- Integrated with EcoStruxure EV Advisor



## ➤ Cloud-based supervision and parking management system integration

- eMobility solution can be connected to a Charging Station Management System - Schneider Electric EcoStruxure EV Advisor or 3<sup>rd</sup> party - and integrated into a parking system managing user access, payment, and more.



With EcoStruxure EV Advisor you can integrate your charging infrastructure with parking management systems, fleet management systems and others via API.



EcoStruxure™ EV Advisor



Parking Management System



Fleet Management System

# Charging infrastructure for underground car parks with 2 EV zones

With EcoStruxure for eMobility, parking and EV-charging offer a fully integrated one-stop service for visitors increasing customer satisfaction and generating new revenues at the same time.

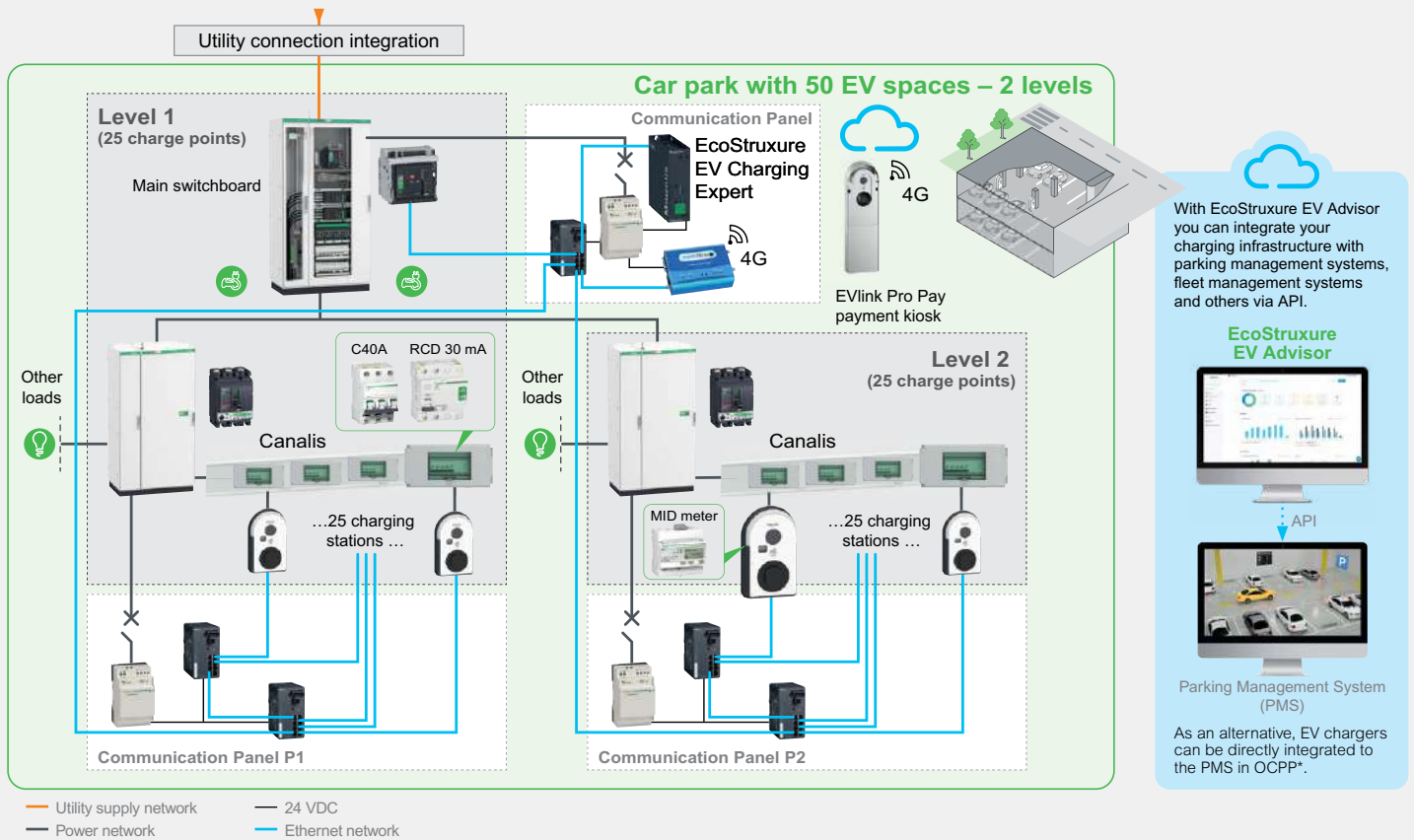

## Customer benefits



### For car park operators:

- Attract EV drivers and create an additional revenue stream
- Offer visitors a one-stop service
- Optimize power availability and reduce energy costs
- Integration with parking management system
- Get technical support and services for your EV infrastructure



### For car park owners:

- Minimize development costs
- Offer an EV service as a path to sustainability
- Get a modular, flexible and scalable charging infrastructure ahead of future needs

\* Find out more details in our Design guide for Building applications.

# eMobility for Buildings Applications

## Charging infrastructure for a Depot with AC and fast DC chargers

EcoStruxure for eMobility is a comprehensive solution combining a line-up of high quality chargers from 7 kW AC to 180 kW DC, tailored electrical distribution, and Schneider Electric load's management expertise: a complete solution that actively helps decarbonize fleet operations.

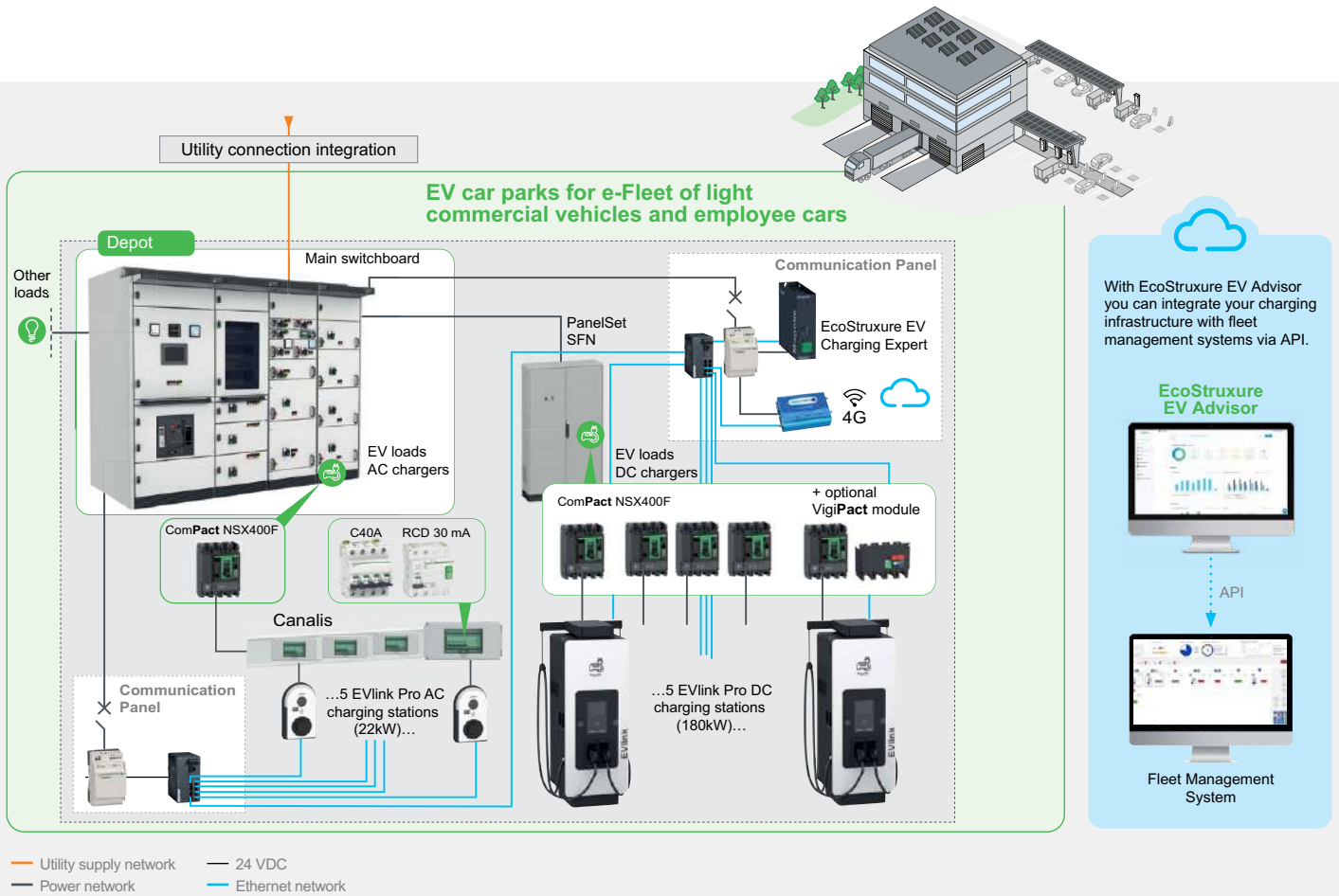

## > Customer benefits



### ▶▶ For fleet managers:

- Decarbonize operations and start the journey to net-zero transportation
- Make certain the fleet is always charged and running on schedule.
- Get a modular, flexible and scalable charging infrastructure to anticipate future needs



### ▶▶ For building owners/managers:

- Install charging infrastructure without compromising building processes
- Comply with new regulations
- Optimize power availability, energy costs and energy consumption
- Deploy lasting protection of the system using PanelSet SFN





# eMobility solutions

## Panorama per Applications

**RESIDENTIAL**  
Single Family Home



**BUILDINGS**  
> Multifamily Home



**APPS,  
ANALYTICS  
AND SERVICES**

**Wiser**  
or 3<sup>rd</sup> party EV charging applications



**eMobility Services**

**EcoStruxure™  
EV Advisor\***

**EDGE  
CONTROL**

**Schneider Charge**  
anti-tripping module 1-phase or 3-phase



**EcoStruxure™  
EV Charging Expert**

**CONNECTED  
PRODUCT**

**Schneider Charge**  
with or without attached cable



**EVlink Pro AC  
EVlink Pro AC Metal**



**Electrical  
distribution  
for eMobility**  
From grid to EV



**iMnx**  
Undervoltage  
release tripping unit

**Acti9 A-Si type**  
Earth leakage  
protection

**Canalis™ busbar trunking system**  
EVlink terminal distribution kit

\*Available soon in selected European countries





> At work



> At destination



> At fleet depot



Maximize the performance of your EV infrastructure and keep your assets running in optimum condition throughout the whole lifecycle, from consulting through to modernization of your park of charging stations.

Remote supervision for charge point operators, contractors and fleet operators, to easily monitor, control and troubleshoot EV charging infrastructure, to manage charging data records, and to collect revenue from EV Drivers.



A charging load management system that helps you to efficiently control your EV infrastructure and smartly distribute available power to your charging stations.



Load Management System



User interface

**EVlink Pro AC**  
**EVlink Pro AC Metal**



**EVlink Pro AC**  
**EVlink Pro AC Metal**  
**EVlink Pro DC 120-180kW**



**EVlink Pro AC**  
**EVlink Pro AC Metal**  
**EVlink Pro DC 120-180kW**



Images of the offers are not contractual.





# Schneider Charge

## Electric Vehicle charging stations and accessories

Schneider Charge.....	p. 20
Please refer to bibliography in Appendix.....	p. 22
Anti-tripping modules .....	p. 23
Cables for EVlink™ Home and Pro AC ranges.....	p. 40



# Schneider Charge

## Characteristics



### Certification

Schneider Charge has obtained the test certificate, establishing compliance with the IEC 61851-1 standard.

### Standards

- EN 61851-1 Ed3.0 (2019)
- EN61000-6-1
- EN61000-6-3
- IEC61851-21-2



- > ROHS compliant
- > Reach compliant
- > EoLi: End Of Life Process
- > Product Environmental Profile compliant

### Charging station offer

Charging power:

**Attached cable version:** 5 m or 7 m with T2 connector:  
7.4 kW single-phase or 11 kW three-phase

#### T2S version:

7,4 kW 1-phase and 11 kW/22 kW 3-phase

- Maximum charging current can be adjusted from 6 A to 32 A
- T2 socket outlet with shutter
- Attached cable (5 m or 7 m) with T2 connector

### Power supply network

- 230 V +/- 10% single-phase - 50-60 Hz for 7,4 kW charging stations
- 400 V +/- 10% three-phase - 50-60 Hz for 11 kW/22 kW charging stations
- Internal protection: 6 mA DC filter
- Suitable earthing systems: TT, TN-S, TN-C-S, IT/TT without Neutral (230 V AC only)

### Mechanical and environmental characteristics

- Ingress protection code: IP55
- Impact protection code: IK10
- Operating temperature:

	T2 socket outlet	Attached cable
1P 32 A	-30...50°C	-35...50°C
3P 16 A	-30...55°C	-35...55°C
3P 32 A	-30...45°C	

- Storage temperature: -40°C to +85°C
- Relative humidity 5% to 95%
- Altitude < 2000 m
- Attached cable length: 5 m for versions supporting it

### Dimension

- Attached cable version: 352x244x107 mm
- T2S version: 352x244x117 mm
- Weight:

	Attached cable	
	1P + N	3P + N
3.3 kg	5m: 4.5 kg 7m: 5.3 kg	5m: 4.5 kg 7m: 5.2 kg

### Installation

- Wall mounting

### Anti-tripping

- Exclusive energy management options: real-time maximum charging current control (with the addition of an external anti-tripping module)
- Power Line Carrier communication between the charging station and the anti-tripping module

### Services offer

- Worldwide network of installers providing on-site installation and commissioning
- Worldwide customer care center

### Commissioning:

- eSetup mobile phone application or Wiser Home (according to your country)

### Operation

#### Interoperable with EV charging applications

- Wiser (France, Germany, Spain, Portugal, Sweden, Norway, Finland, Denmark)
- Third party EV charging applications



## Charging station references

### > Schneider Charge



EVH5A22N2S

Schneider Charge					
References <sup>(1)</sup>	Number of phases	Type of socket	Power kW	Output current	Embedded protection
<b>T2 with shutters</b>					
EVH5A22N2S	1P/3P+N	T2S	(7.4)(11)/22	32A	with 6 mA DC filter
<b>With attached 5 m<sup>(1)</sup> cable and T2 connector</b>					
EVH5A07N2C5	1PH	-	7.4	32A	with 6 mA DC filter
EVH5A11N2C5	3PH	-	11	16 A	with 6 mA DC filter
<b>With attached 7 m<sup>(1)</sup> cable and T2 connector</b>					
EVH5A07N2C7	1PH	-	7.4	32A	with 6 mA DC filter
EVH5A11N2C7	3PH	-	11	16 A	with 6 mA DC filter

<sup>(1)</sup>References to be defined and local availability to be checked by Schneider Electric front offices.

Schneider Charge with TIC <sup>(2)</sup> (France offer)					
References	Number of phases	Type of socket	Power kW	Output current	Embedded protection
<b>T2 with shutters</b>					
EVH5A22N400F	1P/3P+N	T2S	(7.4)(11)/22	32A	with 6 mA DC filter

<sup>(2)</sup>For France only : TIC- Anti-tripping module connected to the energy meter (Linky)

### > Protections and options with Schneider Charge

Description	Single-phase		Three-phase	
Charging	Single-phase		Three-phase	
Rated Power - Current	7.4 kW - 32 A		11 kW - 16 A	22 kW - 32 A
Protection				
Circuit breaker (overcurrent) <sup>(1)</sup>	40 A Curve C		20 A Curve C	40 A Curve C
RCD (residual current) <sup>(1)</sup>	30 mA A-SI Type <sup>(2)</sup>		30 mA A-SI Type <sup>(2)</sup>	30 mA A-SI Type <sup>(2)</sup>
Under voltage tripping auxiliary <sup>(3)(4)</sup>	iMNX		iMNX	iMNX

<sup>(1)</sup> References to be defined and local availability to be checked by Schneider Electric front offices.

<sup>(2)</sup> In accordance with the electrical installation standard HD 60364-7-722:2016. Refer to local regulation.

<sup>(3)(4)</sup> iMNX is mandatory in case of charging station damage following a downstream short circuit.

## Commission and control Schneider Charge from the palm of your hand

### > Wiser

(Available in France, Germany, Spain, Portugal, Sweden, Norway, Finland and Denmark)



#### Easy to sign up:

- Download Wiser on Appstore and Google Store
- Scan your charger QR code to pair your charger

#### Schedule and adapt:

- Plan your charging time
- Adjust your energy mix
- Start the charge, and travel

#### History:

- Track your charging sessions and better understand the energy consumption related to your EV.

### > Third-party EV charging applications

Monitor, control the EV charging station, and much more

- Monitoring, scheduling and cost optimization.
- Plus other features depending on the application (smart charging, grid services...)

# Schneider Charge

## ➤ Charging stations dimensions

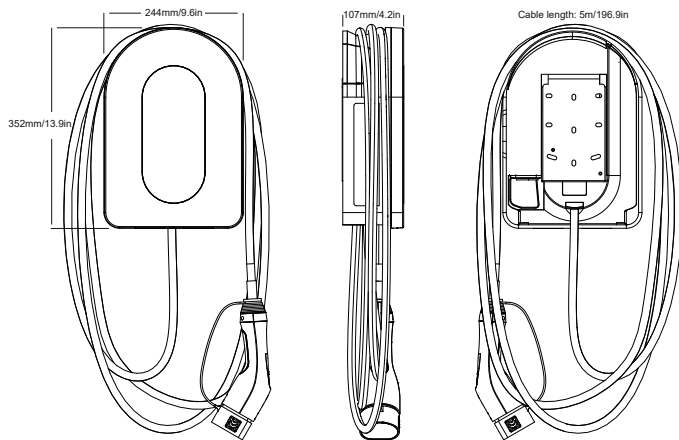
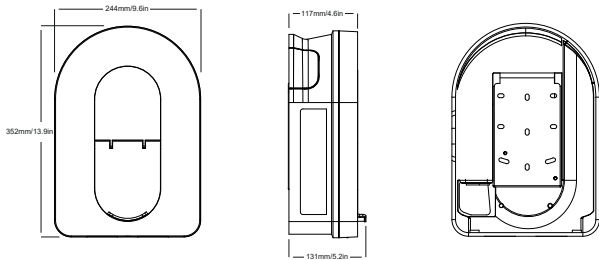

### With socket outlets

- ⦿ ≈ 3.2 kg (7.05 lb)  
T2 – 7.4 kW / 11 kW / 22 kW

### With attached cable

- ⦿ 5 m ≈ 4.5 kg (9.92 lb) – 7.4 kW  
7 m ≈ 5.3 kg (11.68 lb) – 7.4kW
- ⦿ 5 m ≈ 4.5 kg (9.92 lb) – 11 kW  
7 m ≈ 5.2 kg (11.46 lb) – 11 kW



## Accessory references

### EVlink Cable for T2 and T2S charging station



To connect the car to the charging station. Available in different lengths with a T2 connector.

Please refer to page 40

### Technical documentation

Please refer to bibliography in Appendix

# Anti-tripping module



## Characteristics

1-phase Universal Peak controller:



EVA4HPC1  
from 16 A to 50 A

EVA2HPC1  
from 32 A to 100 A

3-phase Universal Peak controller:



EVA2HPC3  
from 16 A to 50 A

### Standards

EN 61326-1-2013  
EN 61010-1-2010

### Main function

- Home Anti-tripping is a power load management system that adapts the power supplied to charge the car continuously, taking home consumption into account\*.
- The power availability is calculated by the Home Anti-tripping System comparing the utility power limit and the home consumption gathered by a current transformer positioned on the bottom of the main circuit breaker.
- For photovoltaic application it continuously adapts the charging power taking home consumption and self-generated energy (PV, wind, storage...) into account.

\* The Anti-Tripping Module limits the maximum power draw of the charging station, in some cases completely stopping the charging according to the power available in the electrical installation, especially if the home is equipped with a heat pump. Minimum recommendation: 25A 3P+N.

### Pairing functionality:

- Pairing functionality with Schneider Charge charging station. Up to 6 pairs can be used at the same time within PLC function range (200-meter power cable length).

### Power supply network and electrical characteristics

- 220/230 V (+/- 10%) 50 Hz (+/- 10%)
- TT, TN, IT/TT without Neutral (230V AC only)
- Rated power 4W
- Overvoltage category: III, Pollution degree: 2
- Insulation degree: reinforced insulation

### Mechanical and environmental

- Dimension 70.4 x 93.2 x 68.8 mm
- Weight 196 g
- Mounting type: Top-hat rail mounting
- Nominal temperature -30°C to +50°C

### Settings

- Possible current value settings:
- 1P (EVA4HPC1): 16A, 20A, 25A, 32A, 40A and 50A
- 1P-HR (EVA2HPC1): 32A, 40A, 50A, 63A, 80A and 100A
- 3P (EVA2HPC3): 16A, 20A, 25A, 32A, 40A and 50A

### Communication

- Communication with Schneider Charge range of charging stations via Power Line Carrier

Technical documentation

Please refer to bibliography in Appendix





# EVlink™ Pro AC and Pro AC Metal

## Electric Vehicle charging stations and accessories

EVlink™ Pro AC .....	p. 26
EVlink™ Pro AC Metal.....	p. 29
Customization .....	p. 36
EVlink Pro AC solutions.....	p. 37
Range accessories and spare parts.....	p. 38
Cables for EVlink™ Home and Pro AC ranges.....	p. 40





# EVlink™ Pro AC

## Characteristics



### Certification

EVlink Pro AC has been certified according to the IEC 61851-1 ed3.0 standard by the DEKRA certification body

### Standards

IEC/EN 61851-1 Ed 3.0  
 IEC/EN 62196-1 Ed 2.0 - IEC/EN 62196-2 Ed 1.0  
 IEC 60364-7-722 Ed.2  
 EMC IEC 61851-21-2  
 EMC EN 301 489-1 V2.1.1 - EN 301 489-17 V3.1.1  
 Upgradable to ISO 15118 Plug and Charge  
 EV Ready

### Power supply network

- 220 - 240 V AC single-phase – 50/60 Hz for 7.4 kW charging stations
- 380 - 415 V AC three-phase – 50/60 Hz for 11 and 22 kW charging stations

### Earthing system

- TT, TN-S, TN-C-S
- 3 phases versions with embedded RCD (A or B) are not compliant with single phase distribution or 3x230 Vac (ph-ph) distribution
- EVlink Pro AC is compatible with IT single-phase network only, and is not compatible with 400V 3-phase IT network

### Rated charging current

- T2S socket outlet with shutters and silver-plated contacts: 16 A to 32 A (factory setting: 32 A)
- TE or TF domestic socket-outlet: 10 A
- T2 attached cable, length 5 meters: 16 A to 32 A
- Socket-outlet on the front

### Mechanical and environmental characteristics

- Ingress protection code: suitable for indoor and outdoor use
  - IP55 with T2S socket-outlet
  - IP55 with attached cable
  - IP54 with domestic socket
- Impact protection code: IK10
- Ambient air temperature for operation: -30°C to +50°C (+40°C for EVlink Pro AC with embedded RCD type Asi)
- Ambient air temperature for storage: -40°C to +80°C (+70°C for EVlink Pro AC with embedded RCD type Asi)
- Energy management options:
  - via digital inputs: limited current, postponed/suspended charge,
  - dynamic energy management combined with TIC interface with French utility meter or universal energy meter
- EV presence detection via digital input

### Access control modes

- Free access
- User authentication through RFID or NFC badge
  - NFC 13.56 MHz reader compatible with type 1, 2, 4 and 5 badges
  - RFID reader:
    - conforming to ISO/IEC 14443 A and B and ISO/IEC 15693 protocols,
    - compatible with Mifare Ultralight, Mifare Classic, Mifare Plus

### Embedded protection and metering

(depending on commercial references)

- Earth leakage protection: RDC-DD 6 mA + RCD type Asi 30 mA or RCD type B-EV
- Undervoltage tripping auxiliary MNx
- MID energy meter
- Metering board and CTs 1% accuracy

### Easy to install and commission

- Wall mounting or floor standing
- 1 or 2 charging stations on the same pedestal
- Parameter setting through eSetup app via Bluetooth or EcoStruxure EV Charging Expert

### Versatile connection to a supervision

- Wired Ethernet: 2 ports (1 for daisy chain)
- Connection through embedded or external 3G/4G modem as an accessory
- OCPP 1.6 Jsn Smart Charging interface

### Services

- Worldwide customer care center
- Additional 1- or 3-year Warranty Extension
- On-site or remote commissioning support
- Services Plan
- Schneider Electric manufactured spare parts
- Advanced on-site training
- Worldwide network of partners providing on-site installation, commissioning and maintenance services



## Charging station commercial references

### EVlink Pro AC

Commercial references <sup>(1)</sup> <sup>(2)(7)</sup>	Type of socket	Domestic socket	Output current	Power kW	Number of phases	Embedded protection	Embedded protection <sup>(4)</sup>	Protection supplied	Embedded MID meter <sup>(6)</sup>
EVB3S07NC0	Att T2 <sup>(5)</sup>	-	32 A	7.1	1PH	RDC-DD 6 mA	MNx	-	-
EVB3S07N40M	T2S	-	32 A	7.4	1PH	RDC-DD 6 mA	MNx	-	Yes
EVB3S07N40EM	T2S	TE	32 A	7.4	1PH	RDC-DD 6 mA	MNx	-	Yes
EVB3S07N4AM	T2S	-	32 A	7.4	1PH	RDC-DD 6 mA + RCD Asi 30 mA	MNx	-	Yes
EVB3S07N4EAM	T2S	TE	32 A	7.4	1PH	RDC-DD 6 mA + RCD Asi 30 mA	MNx	-	Yes
EVB3S07NCAM	Att T2 <sup>(5)</sup>	-	32 A	7.4	1PH	RDC-DD 6 mA + RCD Asi 30 mA	MNx	-	Yes
EVB3S07N4A	T2S	-	32 A	7.4	1PH	RDC-DD 6 mA + RCD Asi 30 mA	MNx	-	-
EVB3S07N4EA	T2S	TE	32 A	7.4	1PH	RDC-DD 6 mA + RCD Asi 30 mA	MNx	-	-
EVB3S07NCA	Att T2 <sup>(5)</sup>	-	32 A	7.4	1PH	RDC-DD 6 mA + RCD Asi 30 mA	MNx	-	-
EVB3S07N4E1	T2S	TE	32 A	7.4	1PH	RDC-DD 6mA	-	-	-
EVB3S07N41	T2S	-	32 A	7.4	1PH	RDC-DD 6mA	-	-	-
EVB3S11N4A	T2S	-	16 A	11	3PH	RDC-DD 6 mA + RCD Asi 30 mA	MNx	-	-
EVB3S11NCA	Att T2 <sup>(5)</sup>	-	16 A	11	3PH	RDC-DD 6 mA + RCD Asi 30 mA	MNx	-	-
EVB3S11N4FB	T2S	TF	16 A	11	3PH	RCD B EV	MNx	-	-
EVB3S22NC0	Att T2 <sup>(5)</sup>	-	32 A	22	3PH	RDC-DD 6mA	MNx	-	-
EVB3S22N4	T2S	-	32 A	22	3PH	RDC-DD 6 mA	MNx	-	-
EVB3S22N4E	T2S	TE	32 A	22	3PH	RDC-DD 6 mA	MNx	-	-
EVB3S22N4A	T2S	-	32 A	22	3PH	RDC-DD 6 mA + RCD Asi 30 mA	MNx	-	-
EVB3S22NCA	Att T2 <sup>(5)</sup>	-	32 A	22	3PH	RDC-DD 6 mA + RCD Asi 30 mA	MNx	-	-
EVB3S22N4EA	T2S	TE	32 A	22	3PH	RDC-DD 6 mA+ RCD Asi 30 mA	MNx	-	-
EVB3S22N4B	T2S	-	32 A	22	3PH	RCD B EV	MNx	-	-
EVB3S22NCB	Att T2 <sup>(5)</sup>	-	32 A	22	3PH	RCD B EV	MNx	-	-
EVB3S22N4EB	T2S	TE	32 A	22	3PH	RCD B EV	MNx	-	-
EVB3S22N4FB	T2S	TF	32 A	22	3PH	RCD B EV	MNx	-	-
EVB3S22N4E1	T2S	TE	32 A	22	3PH	RDC-DD 6mA	-	-	-
EVB3S22N41	T2S	-	32 A	22	3PH	RDC-DD 6mA	-	-	-
EVB3S22N40M	T2S	-	32 A	22	3PH	RDC-DD 6 mA	-	-	Yes
EVB3S22N40EM	T2S	TE	32 A	22	3PH	RDC-DD 6 mA	-	-	Yes
EVB3S22N40FM	T2S	TF	32 A	22	3PH	RDC-DD 6 mA	-	-	Yes
EVB3S22NC0M	Att T2 <sup>(5)</sup>	-	32 A	22	3PH	RDC-DD 6 mA	-	-	Yes
EVB3S22N40MR <sup>(3)</sup>	T2S	-	32 A	22	3PH	-	-	RCD B EV+MNx	Yes

1) Cable for T2S charger available as an accessory

2) Includes 1 RFID badge

3) Recommended for metallic charger, this specific charging station only measures the power consumption of the electric vehicle

4) An MNx under voltage tripping auxiliary is mandatory in case of charging station damage following a downstream short circuit

5) Attached cable with T2 connector

6) MID certified energy meter, IEC accuracy class 1, B (active)

7) All 3-phase references can be wired as 1-phase except those with embedded RCDs

### Protections with EVlink Pro AC

Description	Single-phase	Three-phase
Charging	7.4 kW - 32 A <sup>(2)</sup>	11 kW - 16 A <sup>(2)</sup>
Rated Power - Current	7.4 kW - 32 A <sup>(2)</sup>	11 kW - 16 A <sup>(2)</sup>
Protection		22 kW - 32 A <sup>(2)</sup>
Circuit breaker (overcurrent) <sup>(1)</sup>	40 A Curve C	20 A Curve C
Delayed start		40 A Curve C
Relay	With normally open contact <sup>(3)</sup>	
Temporary current limitation		
Relay	With normally open contact <sup>(3)</sup>	

(1) References to be defined and local availability to be checked by Schneider Electric front offices.

(2) With or without domestic socket.

(3) EVlink Pro AC setting can be changed to "normally closed" if necessary, with the eSetup commissioning app.

Technical documentation

Please refer to bibliography in Appendix

# Practical information

## Practical information

### EVlink Pro AC dimensions

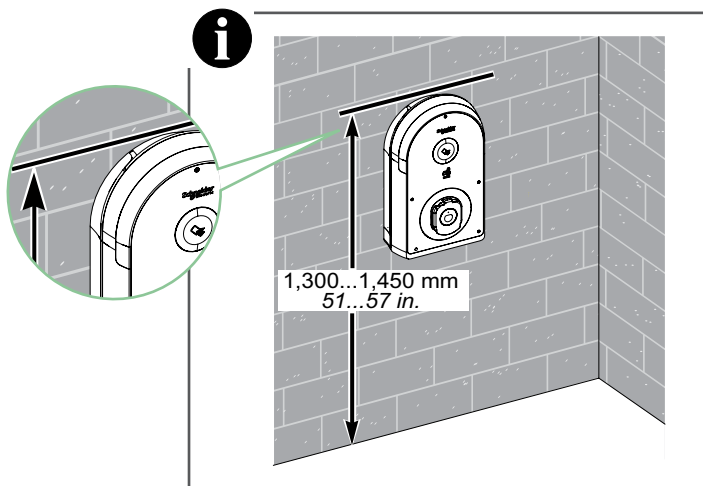
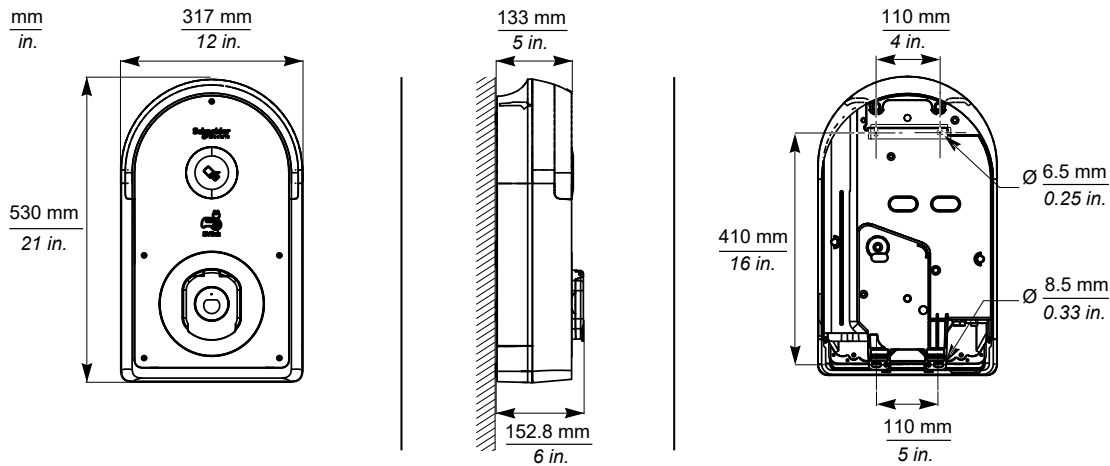

Cable entry from above, below or through the wall



With T2S socket outlet



≈ 7.2 kg (15.43 lb)

With T2 attached cable



≈ 10 kg (22.05 lb)



## Characteristics



EVA1RWKS1



EVA1RFKS1



EVA1RFKS2



> ROHS compliant  
> Reach compliant  
> EoLi: End Of Life Process  
> Product Environmental Profile compliant

### Standards

IEC/EN 61851-1 ed 3.0  
EMC IEC 61851-21-2  
IEC/EN 62196-1 ed 2.0  
IEC/EN 62196-2 ed 1.0  
Enclosures IEC/EN 60529

### Extensive choice

#### Features

The EVlink Pro AC Metal charger is sold as a kit and it is available as:

- Wall mounted 1 charge point
- Floor standing 1 or 2 charge points

#### Design

Refer to page 31 for assembly details.

#### Power supply network

- Same as EVlink Pro AC

#### Mechanical and environmental characteristics

- Charging station: same as EVlink Pro AC
- IP3X Metal enclosure
- IP65 Kaedra enclosure
- IP66 Thalassa enclosure

#### Access control modes

- Same as EVlink Pro AC

#### Services

- Same as EVlink Pro AC

Technical documentation

Please refer to bibliography in Appendix



# EVlink™ Pro AC Metal

## Practical information

### EVlink Pro AC Metal dimensions

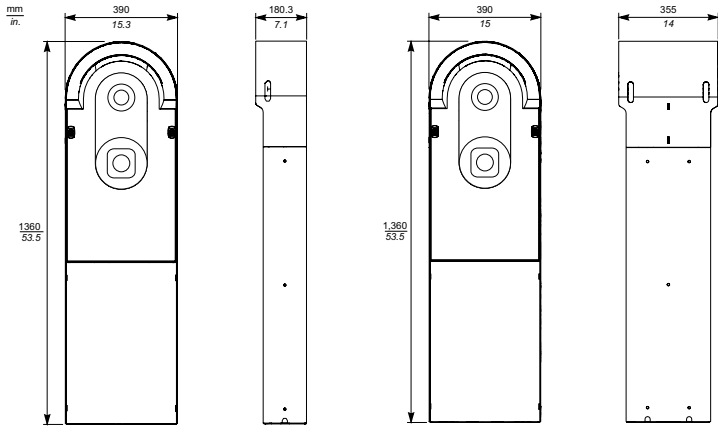

FS1CP: floor standing 1 charge point  
EVA1RFKS1

FS2CP: floor standing 2 charge points  
EVA1RFKS2

WM1CP: wall mounted 1 charge point  
EVA1RWKS1

### EVlink Pro AC Metal assembly time

EVlink Pro AC Metal	Average assembly time
Floor standing 2 charge points	90 to 110 min
Floor standing 1 charge point	50 to 70 min
Wall mounted 1 charge point	50 to 70 min



EVlink Pro AC

≈ 7.2 kg  
(15.43 lb)



EVA1RWKS1

≈ 26 kg  
(79.36 lb)



EVA1RFKS1

≈ 40 kg  
(134.48 lb)



EVA1RFKS2

≈ 61 kg  
(176.37 lb)

### EVlink Pro AC metallic kits

All EVlink Pro AC charging stations can be assembled in any metallic kit.

Part number	Description
EVA1RWKS1	EVlink metallic kit for AC wall mounted 1 charge point
EVA1RFKS1	EVlink metallic kit for AC floor standing 1 charge point
EVA1RFKS2	EVlink metallic kit for AC floor standing 2 charge points

### Enclosures

Depending on the protection chosen to be embedded into the EVlink Pro AC Metal charger, the installation of an enclosure (Kaedra or Thalassa) may be necessary. Refer to the configuration tables on the next pages.



Kaedra 13960



Thalassa EVA1RFKES

Part number	Description
Kaedra IP65 1 x 12 modules of 18 mm - 267 x 200 x 112 mm to install in the EVlink Pro AC metal WM 1CP or FS 1CP and 2 CP	
13979	No terminals
13960M	T terminals
13444	T/N terminals
Thalassa to install in the EVlink Pro AC FS2CP base for one cable entrance up to 35 mm <sup>2</sup>	
EVA1RFKES	<ul style="list-style-type: none"> <li>• 25 and 35 mm<sup>2</sup>- IP66 270x360x180mm</li> <li>• 1 Telequick plate</li> <li>• 2 DIN rail 240 mm max</li> <li>• 4 fixing brackets</li> <li>• Cable glands: 2xM32, 1xM12, 1x5G25/5G36</li> </ul>

# EVlink™ Pro AC Metal

## EVlink Pro AC Metal assembly criteria

### > Wall mounted, floor standing, 1-or 2 charge points

EVlink Pro AC Metal is designed to be handled, assembled and installed by only one person. The necessary components for assembling the EVlink Pro AC Metal are the following:

- 1 A metallic kit enclosure: wall mounted for 1 charge point or floor standing for 1 or 2 charge points
- 2 EVlink Pro AC charging station to be installed inside the metal enclosure, various commercial reference possibilities (see details on p 27)
- 3 Electrical protection to be installed in the switchboard
- 4 Kaedra and Thalassa enclosures to be installed in the metal enclosure for hosting the electrical protection (optional)

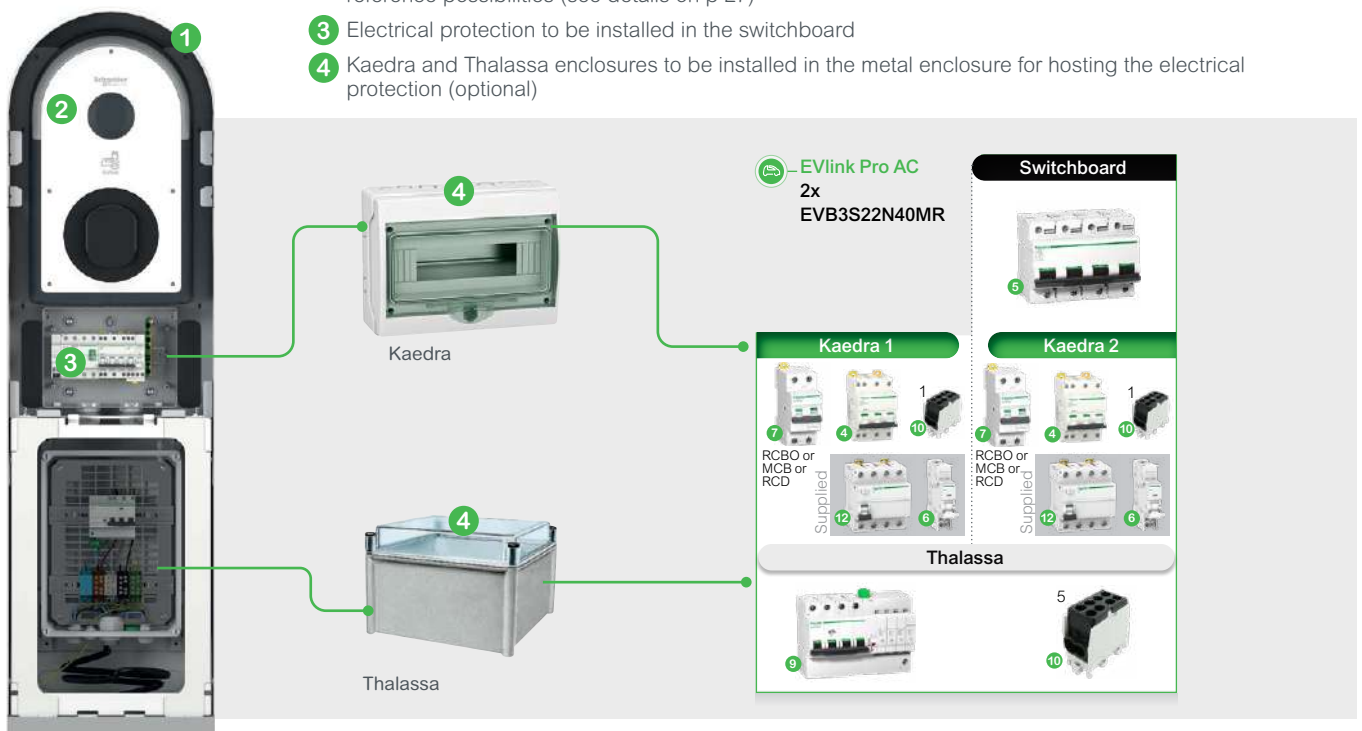

### > Legend



# EVlink™ Pro AC Metal

## ➤ One-Cable, One-Charger

**EVlink Pro AC**  
EVB3S22N40MR

**Switchboard**

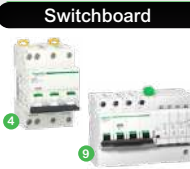

**Kaedra**



Supplied

**EVlink Pro AC**  
EVB3S22N4A or  
EVB3S22N4B or  
EVB3S22N4C or  
EVB3S22N4CB or  
EVB3S22N4EB or  
EVB3S22N4FB or  
EVB3S22N4EA

**Switchboard**



**Kaedra**



**EVlink Pro AC**  
EVB3S22N40M or  
EVB3S22NC0M or  
EVB3S22N40EM or  
EVB3S22N40FM

**Switchboard**



**Kaedra**



Supplied

**EVlink Pro AC**  
EVB3S07N40M or  
EVB3S07N40EM

**Switchboard**



**Kaedra**



Supplied

**EVlink Pro AC**  
EVB3S22N4 or  
EVB3S22N4E or  
EVB3S22NC0

**Switchboard**



**Kaedra**



**EVlink Pro AC**  
EVB3S07NC0

**Switchboard**



**Kaedra**



**EVlink Pro AC**  
EVB3S11N4A or  
EVB3S11N4C or  
EVB3S11N4FB

**Switchboard**



**Kaedra**



**EVlink Pro AC**  
EVB3S07N4A or  
EVB3S07N4C or  
EVB3S07N4EA or  
EVB3S07N4AM or  
EVB3S07N4CAM or  
EVB3S07N4EAM

**Switchboard**



**Kaedra**



**EVlink Pro AC**  
EVB3S22N41 or  
EVB3S22N4E1

**Switchboard**



**Kaedra**



- 1 MCB 1P+N 40 A
- 2 MCB 2P 80 A
- 3 MCB 3P+N 20 A
- 4 MCB 3P+N 40 A
- 5 MCB 4P 80 A

- 6 MNx
- 7 RCBO
- 8 SPD 1P+N
- 9 SPD 3P+N
- 10 Terminal connector 25 mm<sup>2</sup>

- 11 Type Asi RCD monophasé
- 12 Type Asi RCD triphasé
- 13 Type B RCD triphasé



# EVlink™ Pro AC Metal



## ➤ One-Cable, One-Charger

**EVlink Pro AC**  
EVB3S07N41 or  
EVB3S07N4E1

**Switchboard**



**Kaedra**



- 1 MCB 1P+N 40 A
- 2 MCB 2P 80 A
- 3 MCB 3P+N 20 A
- 4 MCB 3P+N 40 A
- 5 MCB 4P 80 A
- 6 MNx
- 7 RCBO
- 8 SPD 1P+N
- 9 SPD 3P+N
- 10 Terminal connector 25 mm<sup>2</sup>
- 11 Type Asi RCD monophasé
- 12 Type Asi RCD triphasé
- 13 Type B RCD triphasé

## ➤ One-Cable, Two-Chargers

**EVlink Pro AC**  
2x  
EVB3S2240MR

**Switchboard**



**Kaedra 1**

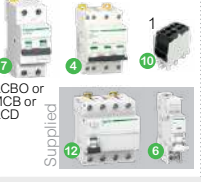

RCBO or  
MCB or  
RCD

Supplied

**Kaedra 2**



RCBO or  
MCB or  
RCD

Supplied

**Thalassa**



**EVlink Pro AC**  
2x  
EVB3S22N40M or  
EVB3S22NC0M or  
EVB3S22N40EM or  
EVB3S22N40FM

**Switchboard**



**Kaedra 1**



Supplied

**Kaedra 2**



Supplied

**Thalassa**



**EVlink Pro AC**  
2x  
EVB3S07N40M or  
EVB3S07N40EM

**Switchboard**



**Kaedra 1**

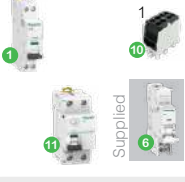

Supplied

**Kaedra 2**



Supplied

**Thalassa**



**EVlink Pro AC**  
2x  
EVB3S22N4 or  
EVB3S22N4E or  
EVB3S22NC0

**Switchboard**



**Kaedra 1**



**Kaedra 2**



**Thalassa**



**EVlink Pro AC**  
2x  
EVB3S07NC0

**Switchboard**



**Kaedra 1**



**Kaedra 2**



**Thalassa**



**EVlink Pro AC**  
2x EVB3S22N4A or  
EVB3S22N4B or  
EVB3S22NCA or  
EVB3S22NCB or  
EVB3S22N4EB or  
EVB3S22N4FB  
+ EVB3S22N4EA

**Switchboard**

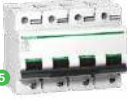

**Kaedra 1**



**Kaedra 2**



**Thalassa**



# EVlink™ Pro AC Metal

## ➤ One-Cable, Two-Chargers

**EVlink Pro AC**  
2x  
EVB3S11N4A or  
EVB3S11NCA or  
EVB3S11N4FB

**Switchboard**

**Kaedra 1**

**Kaedra 2**

**Thalassa**

**EVlink Pro AC**  
2x EVB3S07N4A or  
EVB3S07NCA or  
EVB3S07N4EA or  
EVB3S07N4AM or  
EVB3S07NCAM or  
EVB3S07N4EAM

**Switchboard**

**Kaedra 1**

**Kaedra 2**

**Thalassa**

**EVlink Pro AC**  
2x  
EVB3S22N41 or  
EVB3S22N4E1

**Switchboard**

**Kaedra 1**

**Kaedra 2**

**Thalassa**

**EVlink Pro AC**  
2x  
EVB3S07N41 or  
EVB3S07N4E1

**Switchboard**

**Kaedra 1**

**Kaedra 2**

**Thalassa**

- 1 MCB 1P+N 40 A
- 2 MCB 2P 80 A
- 3 MCB 3P+N 20 A
- 4 MCB 3P+N 40 A
- 5 MCB 4P 80 A
- 6 MNx
- 7 RCBO
- 8 SPD 1P+N
- 9 SPD 3P+N
- 10 Terminal connector 25 mm²
- 11 Type Asi RCD monophasé
- 12 Type Asi RCD triphasé
- 13 Type B RCD triphasé

## ➤ Dual cable entrance, Two-Chargers

**EVlink Pro AC**  
2x  
EVB3S22N40MR

**Switchboard**

**Kaedra 1**

**Kaedra 2**

**EVlink Pro AC**  
2x  
EVB3S22N40M or  
EVB3S22NC0M or  
EVB3S22N40EM or  
EVB3S22N40FM

**Switchboard**

**Kaedra 1**

**Kaedra 2**

**EVlink Pro AC**  
2x  
EVB3S07N40M  
EVB3S07N40EM

**Switchboard**

**Kaedra 1**

**Kaedra 2**

# EVlink™ Pro AC Metal



## ➤ Dual cable entrance, Two-Chargers

**EVlink Pro AC**  
2x  
EVB3S22N4 or  
EVB3S22N4E or  
EVB3S22NC0

**Switchboard**  
2x  
2x  
2x  
4

**Kaedra 1**

**Kaedra 2**

**EVlink Pro AC**  
2x  
EVB3S07NC0

**Switchboard**  
2x  
2x  
2x  
1

**Kaedra 1**

**Kaedra 2**

**EVlink Pro AC**  
2x EVB3S22N4A or  
EVB3S22N4B or  
EVB3S22NCA or  
EVB3S22NCB or  
EVB3S22N4EB or  
EVB3S22N4FB or  
EVB3S33N4EA

**Switchboard**  
2x  
4

**Kaedra 1**

**Kaedra 2**

**EVlink Pro AC**  
2x  
EVB3S11N4A or  
EVB3S11NCA or  
EVB3S11N4FB

**Switchboard**  
2x  
3

**Kaedra 1**

**Kaedra 2**

**EVlink Pro AC**  
2x  
EVB3S07N4A or  
EVB3S07NCA or  
EVB3S07N4EA or  
EVB3S07N4AM or  
EVB3S07NCAM or  
EVB3S07N4EAM

**Switchboard**  
2x  
1

**Kaedra 1**

**Kaedra 2**

**EVlink Pro AC**  
2x  
EVB3S22N41 or  
EVB3S22N4E1

**Switchboard**  
2x  
4

**Kaedra 1**

**Kaedra 2**

**EVlink Pro AC**  
2x  
EVB3S07N41 or  
EVB3S07N4E1

**Switchboard**  
2x  
1

**Kaedra 1**

**Kaedra 2**

- 1 MCB 1P+N 40 A
- 2 MCB 2P 80 A
- 3 MCB 3P+N 20 A
- 4 MCB 3P+N 40 A
- 5 MCB 4P 80 A
- 6 MNx
- 7 RCBO
- 8 SPD 1P+N
- 9 SPD 3P+N
- 10 Terminal connector 25 mm<sup>2</sup>
- 11 Type Asi RCD monphasé
- 12 Type Asi RCD triphasé
- 13 Type B RCD triphasé

Technical documentation

Please refer to bibliography in Appendix

# Customization

The EVlink Pro AC customization can be executed through local partners with the help of the product drawings below.

## ➤ EVlink Pro AC



- The front plate can be customized.
- The material is PC BAYLOY 10 UV white 3.

## ➤ EVlink Pro AC Metal



- The metallic enclosure can be customized.
- The material is electrogalvanized steel.

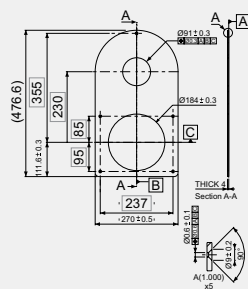

Schneider Electric provides the 2D plan with dimensions to produce the customized sticker [se.com/EVlink](https://se.com/EVlink).



# EVlink™ Pro AC

## EVlink Pro AC solutions

### ➤ EVlink Pro AC to measure the consumption of the EV only

A specific commercial reference is available with power and control supply separated and embedded MID meter.



EVB3S22N40MR

Commercial reference	<b>EVB3S22N40MR</b>
Type of socket	T2S
Current output	32 A
Power kW	22
Number of phases	3 PH
Protection supplied	RCD B EV+MNx
MID inside	Yes

### ➤ EVlink Pro Pay payment kiosk

EVlink Pro Pay offers an ad-hoc payment kiosk that can manage up to 15 charging points, is compliant with AFIR regulation and fully integrated with EcoStruxure EV Advisor.



EVPROPAY

Payment	Contactless payment, PIN entry Digital receipt via QRcode VISA, Vpay, Mastercard, Maestro, Apple/Google Pay
Installation	Wall mounted or floor standing Robust (Pro Metal kit)
Mechanical and environmental characteristics	IP 55 IK 10 for the product IK 9 for the screen
Power Supply	230V, 50hz
Certifications	CE, UK Standards - IEC62368-1 Payment terminal - PCI PTS 6.X

Contact your local sales representative for more details on the payment kiosk solution. Please note that additional actions with payment service provider and payment terminal manufacturer are required to process payment transactions. Check with your CSMS provider that they support Payter Apollo terminals in kiosk mode.

# Range accessories and spare parts

## Accessories references

### ➤ EVlink Pro AC and Pro AC Metal

#### 4G Kits

- 4G embedded modem dedicated for architecture up to 10 EVlink Pro AC
- Cost-efficient solution for remote monitoring applications
  - 1 device to manage wireless communication of up to 10 charging stations
  - Compact and directly integrated inside the charging station.

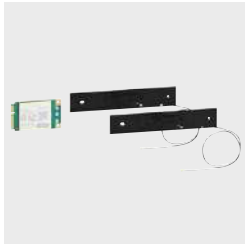

Embedded 4G modem with 2 internal antennas for EVlink Pro AC.  
Reference: **EVA1MS**



Embedded 4G modem with an external antenna for EVlink Pro AC Metal  
Reference: **EVA1MM**



External modem for architecture with more than 10 EVlink Pro AC and/or EcoStruxure EV Charging Expert  
Manage wireless communication of large infrastructure and installation requiring load management.  
Modem reference: **EVP3MM**  
Antenna reference: **EVP2MX**

#### Pack of 10 RFID badges



For charging stations equipped with an RFID reader. The badges are supplied blank, ready to be programmed to identify an administrator or user. Sheet of adhesive labels for badges: 1 administrator + 9 users.  
Reference: **EVP1BNS**

#### TIC interface



Energy management: Smart meter connection to Historical and Standard TIC Tele Information Client card EVlink interface with French utility meters.  
Reference: **EVA1MTH**

#### EVlink Cable



To connect the car to the charging station. Available in different lengths with a T2 connector.

Please refer to page 40

### ➤ EVlink Pro AC specific

#### Pedestal mounting pole



- Floor standing:
- for 1 EVlink Pro AC,  
Reference: **EVA1PBS1**  
H 1300 x W 285 x D 229 mm
  - for 2 EVlink Pro AC,  
Reference: **EVA1PBS2**  
H 1300 x W 285 x D 384 mm
  - Plate to convert the pedestal for 1 charger to a pedestal for 2 chargers.  
Reference: **EVA1PCS2**

#### Permanent cable locker



To keep the cable attached permanently to the charging station.  
Reference: **EVA1PLS1**

## Accessories references

### ➤ EVlink Pro AC Metal Kit accessories

#### Cable holder



Allows the cable to be left connected on the side charging station. The cable holder is mandatory for charging stations with attached cable. In case of charging station with socket, it can allow to lock the accessory cable. Reference: **EVA1FWHS12**

#### Locking accessory





Polyamid handle lock, mainly for cybersecurity purpose, direct mounting on front plate. 1 cylindrical barrel, 2 keys Nr 610, 1 handle with key lock. Reference: **NSYCL610CSX**  
Quantity:  
2 for WM1CP, or 2 for FS1CP, or 4 for FS2CP

## Spare part references

EVlink Pro AC front plate	Reference
	<b>EVP1SS</b>

EVlink Pro AC front plate with cut-out window	Reference
	<b>EVP1SM</b>
Designed with a cut-out window enabling to see the embedded MID meter inside EVlink Pro AC.	

EVlink Pro AC and Pro AC Metal - Socket outlets		References
	1PH socket outlet T2S	<b>EVP1SSS41</b>
	3PH socket outlet T2S	<b>EVP1SSS43</b>
	1PH socket outlet T2S - Domestic TE	<b>EVP1SSS51</b>
	3PH socket outlet T2S - Domestic TE	<b>EVP1SSS53</b>
	1PH socket outlet T2S - Domestic TF	<b>EVP1SSS61</b>
	3PH socket outlet T2S - Domestic TF	<b>EVP1SSS63</b>
	TE domestic socket	<b>EVP1SSSE</b>
	TF domestic socket	<b>EVP1SSSF</b>
EVlink Pro AC and Pro AC Metal - Attached cables		References
<b>T2 charging connector</b>		
	T2 attached cable 1PH 32 A 5 m length	<b>EVP1CSS321C</b>
	T2 attached cable 3PH 32A 5m length	<b>EVP1CSS323C</b>

Technical documentation

Please refer to bibliography in Appendix

# Cables for EVlink™ Home and Pro AC ranges

## Characteristics



Type 2 (T2)



- Tested and certified product: Third-party laboratory CB certification (LCIE) complies with the applicable standard IEC 62196
- Fast charging (Mode 3)
- High-strength cable

### Characteristics

- Length: available in 5, 7 and 10 m
- Max. current: 32 A
- Operating temperature: -30°C to +50°C
- Degree of protection: IP44.

### Two good reasons to have a second EVlink cable in your electric vehicle

1

To take advantage of the charging capacity of public charging stations: by having an appropriate EVlink cable for the charging stations used, you obtain fast charging with integrated protection<sup>(1)</sup>.

2

To have a fallback solution.

E.g. charging cable damaged or misplaced, or to help out another electric vehicle user.

## Which EVlink cable for which electric vehicle?

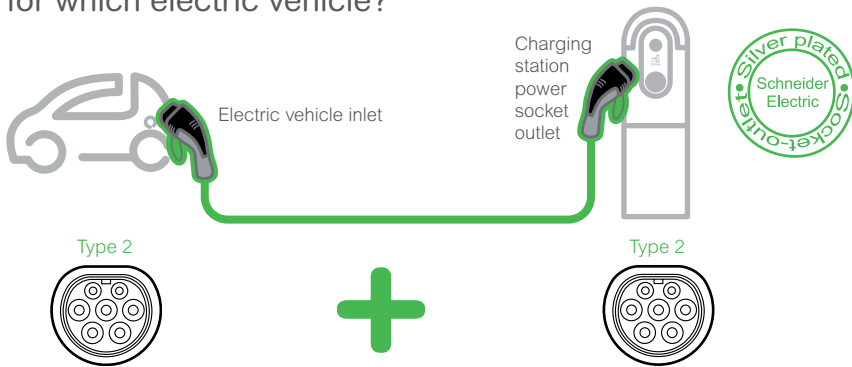

References	No. of phases		Charging power accepted (kW)				Cable length (m)
	1	3	3.7	7.4	11	22	
EVP1CNS32122	●		●	●			5
EVP1CNL32122	●		●	●			7
EVP1CNX32122	●		●	●			10
EVP1CNS32322		●	●	●	●	●	5
EVP1CNL32322		●	●	●	●	●	7
EVP1CNX32322		●	●	●	●	●	10



[\(1\) Learn more on the Wiki guide for Electric Vehicle charging](#)









Schneider  
Electric

DC Meter A

DC Meter B

CC82

CC83

EVlink

# EVlink™ Pro DC

Electric vehicle charging stations

EVlink™ Pro DC 120-150-180 kW ..... p.44



# EVlink™ Pro DC 120-150-180 kW



## In short



### Charging station offer

EVlink DC Pro DC 120 – 150 – 180 kW charging stations are able to charge an electric vehicle in less than 30 minutes.

The range covers a large variety of needs with a choice of either, per station:

- 2 connectors, CCS Combo 2 + CCS Combo 2
- 2 connectors, CHAdeMO + CCS Combo 2

Pro DC 120 – 150 – 180 kW with 2 vehicle connectors is capable to charge one vehicle at full power or simultaneously two vehicles with dynamic power allocation. For instance, to charge one vehicle at 120 kW while charging another one at 60 kW at the same time.

### Easy to install

- Indoor or outdoor
- Floor mounted
- Installation in less than 2 hours (when supply cable is already installed)

### Mechanical and environment features

- Degree of protection: IP55
- Degree of mechanical protection: IK10 – IK08 for the screen
- Operating temperature: -30°C / +50°C (with derating above 50°C)
- Storage temperature: -40°C to 70°C
- Operating altitude: 2000 m max.
- Relative humidity: 5% to 95%
- Housing corrosion protection C4M
- Charge interrupt button
- Accessible to disable people

### Access control modes

- Free Access
- User authentication through RFID or NFC badge
  - NFC 13,56 MHz reader compatible with type 1, 2, 4 and 5 badges
  - RFID reader:
    - conforming to ISO/CEI 14443 A & B and ISO/CEI 15693 protocols,
    - compatible with Mifare Ultralight, Mifare Classic, Mifare Plus
- Auto-charge (EV MAC address)
- QR code for CPO application

### Services

- Worldwide Customer Care Centre
- Additional 1- or 3-years Warranty Extension
- Onsite commissioning support
- Services Plan
- Schneider Electric manufactured Spare parts
- Advanced training
- Worldwide network of Schneider Electric services representatives providing on-site installation, commissioning and maintenance services



### Standards

EV international standard: EN 61851-1 Ed. 3 IEC/  
EN 61851-23 – Ed. 1  
EV connector international standard: IEC/EN  
IEC62196-1 & IEC62196-3  
Immunity for industrial environment: EN 61000-6-2  
Emission for industrial environment: EN 61000-6-4  
EMC for industrial environment: Class A.  
Radio certification  
RFID/NFC: EN 300 330 V2.1.1  
4G: EN 301 908 -13 V13.1.1  
Wi-Fi: EN 300 328 V2.2.2 - EN 301 893  
EMC radio Equipment  
EN 301 489-1 V2.2.0  
RFID/NFC: EMC EN 301 489-3 V2.1.1  
4G: EMC EN 301 489-52 V1.1.0  
Wi-Fi: EMC EN 301 489-17 V2.1.1

## Application

EVlink Pro DC 120 – 150 – 180 kW charging stations are recommended for vehicle depot and traffic application.





## Characteristics



EVD1S120TBB  
EVD1S150TBB  
EVD1S180TBB



EVD1S120THB  
EVD1S150THB  
EVD1S180THB



EVD1S120TBBC7  
EVD1S150TBBC7  
EVD1S180TBBC7

### Power supply network and charging mode

- Power supply: 380 - 400 V - 415 Vac +/- 10% 50/60 Hz
- Poles description: L1+L2+L3+N+PE

### Direct current charging (all charging stations)

- Charging in Mode 4 (IEC 61851-23)
- Charging power:
  - CCS Combo 2 - 120 – 150 – 180 kW
  - CHAdeMO - 60 kW
- Charging voltage/current:
  - CCS Combo 2 - 150 to 1 000 VDC / 300 A Max
  - CHAdeMO 150 to 500 VDC / 125 A Max
- Standby power: 90 W
- Protection against overheating, temperature regulated
- Cable range: 3.6 m with cable management
- Efficiency 94.5% at nominal output power
- Power Factor  $\geq 0.99$  at nominal output power
- THDi  $\leq 5\%$  at nominal output power
- Acoustic noise: Variable under load: 0 dB - 65 dB at 1 m in front of the charger

### Embedded protection and metering

- MCB
- RCD on DC output
- SPD
- Metering: DC Meter class 1 (1% accuracy at full scale) – Compliant with French DC meter regulation

### Diagram of the earthing system

- TT, TN-S, TN-C-S
- IT (Compatible IT on 1-phase ; Compatible IT with additional isolating transformer on the 3-phase power supply)

### Versatile connection to a supervision

- Ethernet
- Wireless 4G modem
- Wi-Fi
- OCPP 1.6Json Smart Charging interface
- ISO15118 / DIN 70121
- LAN/TCP IP protocol

### User interfaces

- 10-inch touch screen (multi-language support: English, French, German, Norwegian, Spanish, Italian, Danish, Vietnamese, Ukrainian...)  
Additional languages to be confirmed with your local Schneider Electric sales representative
- multi-color LED for status indication for each vehicle connector

### Sensors

- Humidity sensor
- Door sensor
- Water ingress sensor

### Dimensions (cabinet with Cable management)

- H 2202 x W 1050 x D 982 mm (H 86.69 x W 41.34 x D 38.67 In.)

### Dimensions (cabinet without Cable management)

- H 2103 x W 833 x D 963 mm (H 83,86 x W 32,80 x D 37,92 In.)

# EVlink™ Pro DC 120-150-180 kW



## Charging station references

EVlink Pro DC 120-150-180 W						
Power	Connector(s)	References <sup>(1)</sup>	Weight without power module	Weight with power module	Cable range	Cable management
120 kW DC	CCS Combo 2 + CCS Combo 2	EVD1S120TBB	~470 kg / 1037 lb	~530 kg / 1168 lb	3.6m	Yes
	CHAdeMO + CCS Combo 2	EVD1S120THB	~470 kg / 1037 lb	~530 kg / 1168 lb	3.6m	Yes
150 kW DC	CCS Combo 2 + CCS Combo 2	EVD1S150TBB	~470 kg / 1037 lb	~545 kg / 1201 lb	3.6m	Yes
	CHAdeMO + CCS Combo 2	EVD1S150THB	~470 kg / 1037 lb	~545 kg / 1201 lb	3.6m	Yes
180 kW DC	CCS Combo 2 + CCS Combo 2	EVD1S180TBB	~470 kg / 1037 lb	~560 kg / 1235 lb	3.6m	Yes
	CHAdeMO + CCS Combo 2	EVD1S180THB	~470 kg / 1037 lb	~560 kg / 1235 lb	3.6m	Yes
120 kW DC	CCS Combo 2 + CCS Combo 2	EVD1S120TBBC7	~451 kg / 995 lb	~511 kg / 1127 lb	7.5m	No
150 kW DC	CCS Combo 2 + CCS Combo 2	EVD1S150TBBC7	~451 kg / 995 lb	~526 kg / 1160 lb	7.5m	No
180 kW DC	CCS Combo 2 + CCS Combo 2	EVD1S180TBBC7	~451 kg / 995 lb	~541 kg / 1193 lb	7.5m	No

(1) References to be defined and local availability to be checked by Schneider Electric front offices.

## Current information and protections

Current information and protections to use with EVlink Pro DC 120 - 150 - 180 kW			
<b>Current</b>			
Power	120 kW	150 kW	180 kW
Rated current	193 A	242 A	291 A
Max. current	214 A	268 A	323 A
<b>Electrical protection</b>			
Circuit breaker (overcurrent)	3P+N or 4P	3P+N or 4P	3P+N or 4P
References	C25F4TM250* or C25F44V2501*	C40F42D400	C40F42D400
Optional RCD protection (VigiPact)	-	LV432465	LV432465

\*Optional RCD protection included.

Note: if there is plan to upgrade later (from 120 to 150 kW or 150 to 180kW...) already consider the protection sizings for DC 180kW.

Technical documentation

Please refer to bibliography in Appendix



GLOBAL

Zones and outlets

ZONES

All zones

1st Floor

1st Floor - North

1st Floor - South

2nd Floor

3rd Floor (VIP)

POWER OUTLETS

All power outlets

PowerMeter1

EXPORT TRANSACTIONS

INFORMATION

DASHBOARD

Station fleet

Stations 23

Cluster power

Charge points 39

available 32

charging 3

suspended by EV 1

suspended by system 1

faulted 2

not connected 0

unavailable 0

CHARGES

0



Charges

Optimal

Reduced

Suspended

charging stations

local production

STATIONS

Name	Zone	Connect
Station 17	2nd Floor - North-East	1
Station 18	2nd Floor - North-East	2
Station 19	2nd Floor - North-East	1
Station 20	2nd Floor - North-East	2
Station 21	2nd Floor - North-East	1
Station 22	2nd Floor - North-East	1
Station 23	2nd Floor - North-West	2
Station 24	2nd Floor - North-West	1
Station 25	2nd Floor - North-West	2
Station 26	2nd Floor - North-West	1



# Energy management, software and digital services

Energy management .....	p. 50
EcoStruxure™ EV Charging Expert .....	p. 52
EcoStruxure™ EV Advisor .....	p. 56

# Energy management

## How to optimize the impact of the charging solution's consumption on an electrical installation ?

The installation of charging stations in an existing electrical network can have a significant impact due to the power level required by electric vehicles to charge. Increasing the power subscribed to the energy supplier increases the cost but the trigger threshold can still be exceeded with potential discontinuity of service for all the activities.

EcoStruxure EV Charging Expert allows EV loads to be monitored, controlled and maximized based on the real-time available power in the building.

It helps to ensure the respect of cost and energy efficiency constraints of a set of charging stations by controlling their operation. The controller runs its management program according to the selected parameters and data received from the charging stations.



### Static and dynamic energy management principles

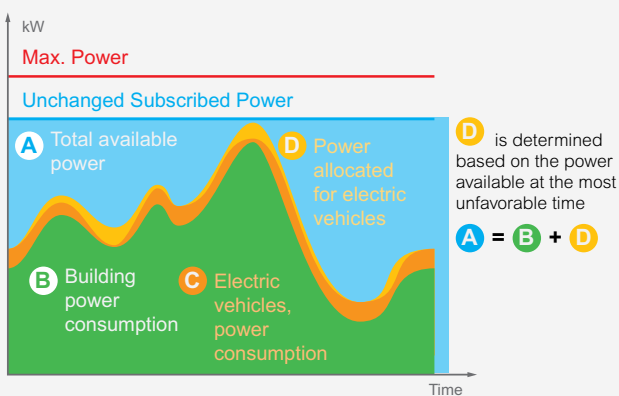

Static energy management: D is determined based on the available power at the most unfavorable time and is constant over time.

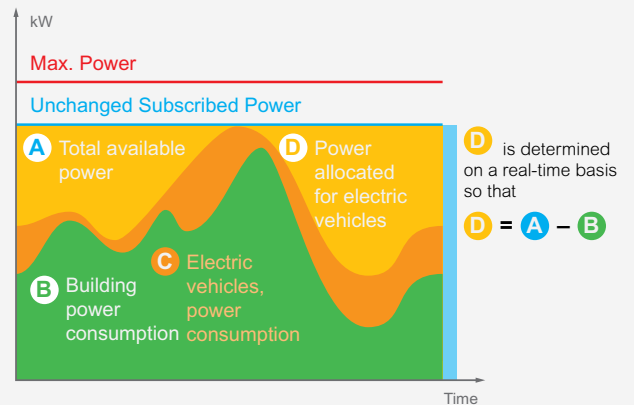

Dynamic energy management: setpoint "D" is adjusted in real time according to the consumption of the rest of loads in the building, to maximize the power allocated to charging electric vehicles.

### Electrical installation with energy management

From 1 to 100 charging stations depending on selected EV Charging Expert model.

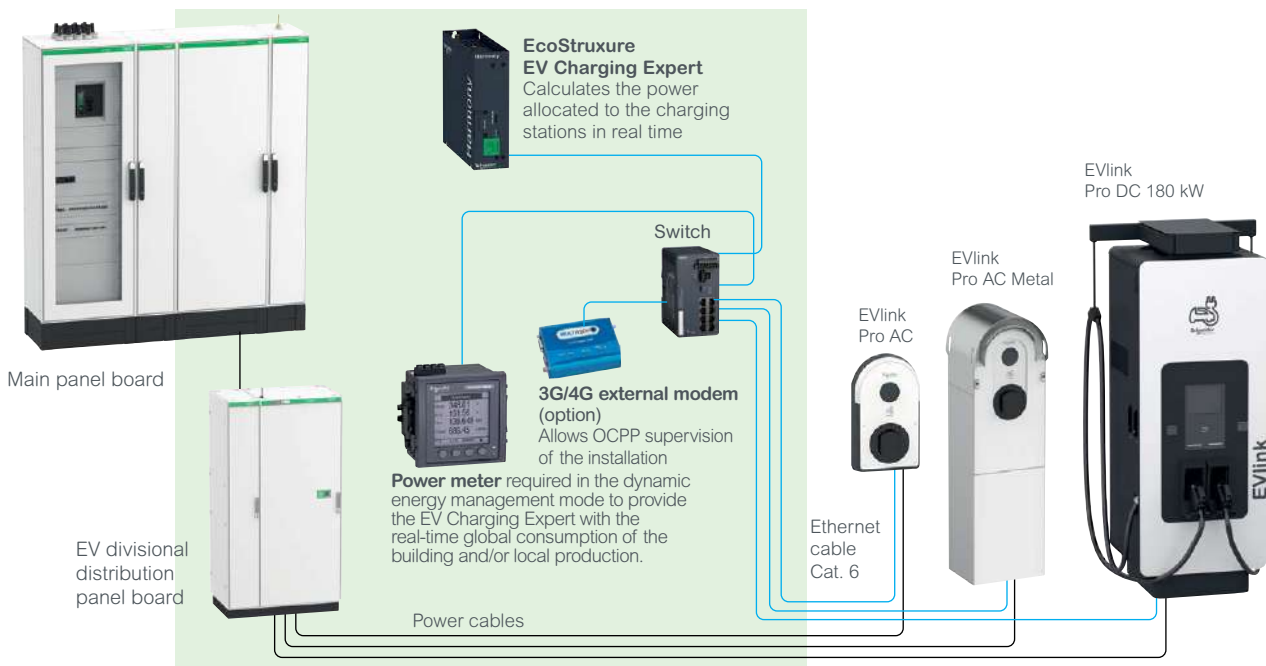

[Discover more installation guidelines for EcoStruxure EV Charging Expert](#)

## ➤ Operation

- EcoStruxure EV Charging Expert controls the EV charging infrastructure
- It allows the instantaneous power drawn by the entire set of connected electric vehicles to be limited, and manages the energy allocated to each one of them in order to simultaneously supply as many EVs as possible.
- In real time, it transmits a setpoint to each charging station, which is transferred to the vehicles
- If the max current allowed in a zone is reached, a decrease in energy is applied in the same way to all charge points (51% in the example with 17 kW of available power)
- Output is only reduced on the electrical phases that need it.

### Descriptive example to illustrate the load reduction and load-shedding operation

Available power in the building allocated to EV charging

Delivered charging power

Description

33.1 kW ➤

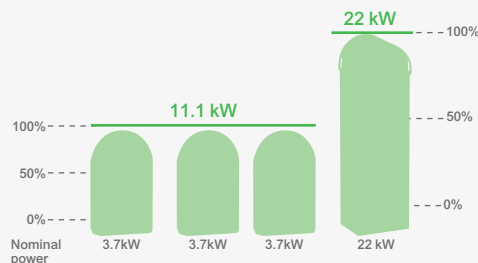

The full available energy is delivered.

12 kW ➤

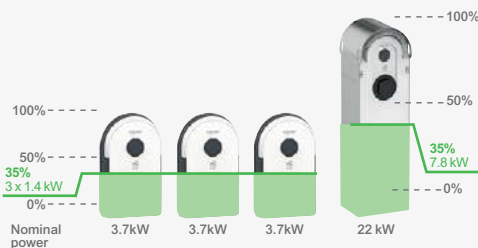

When reaching the minimum current setpoint of a charge point, its current level will be maintained so that the EV keeps charging.

#### Details

Min. current for an EV to charge (according to IEC 61851) = 6 A, representing 1.4 kW of a 3.7 kW charging station.  
 $12 - (3 \times 1.4 \text{ kW}) = 7.8 \text{ kW}$ , that are provided by the 22 kW charging station.

7.5 kW ➤

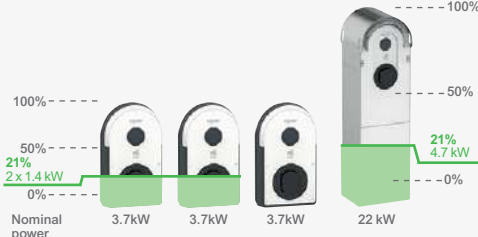

If there is not enough power to feed all the charging stations, charge point load shedding will be triggered, following the load-shedding rules.

#### Details

With 6 A (1.4 kW) per active charging station (IEC 61851 minimum current), the 7.5 kW of charging power are respected by switching off 1 charging station.  
 $7.5 - (2 \times 1.4 \text{ kW}) = 4.7 \text{ kW}$ , that are provided by the 22 kW charging station.

## ➤ Load shedding rules between charging sessions

When the load shedding is triggered (meaning there is not enough power to continue all the charging sessions simultaneously), the algorithm allows the available energy to be distributed according to 2 strategies (depending on the settings):

- Based on the energy already consumed: the system interrupts the charging of the vehicles that have obtained the highest amount of kWh since the start of their charging, favoring recently arrived vehicles.
- Based on the connection time: the system interrupts the charging of the vehicles with the longest charging time, favoring those last arrived.

In both cases, the system rechecks and updates the situation every 15 minutes.

# EcoStruxure™ EV Charging Expert



## EcoStruxure EV Charging Expert



EV Charging Expert has been awarded with the prestigious "Solar impulse Efficient Solution" label.



[Find out more here](#)

EcoStruxure EV Charging Expert allows EV charging to be monitored, controlled and maximized based on the real-time available power in the building.

It helps to ensure the respect of cost and energy efficiency constraints of a set of charging stations by controlling their operation. The controller runs its management program according to the selected parameters and data received from the charging stations.

### Characteristics

- PLC type: Harmony iPC IIoT Edge Box Core
- Operating system: Linux Yocto
- Supply voltage: 12...24 V DC
- Inrush current: 0.43 A
- Consumption: 16 W
- Dimensions: 150 x 46 x 157 mm
- Protection class: IP40
- Standards/Directives:
  - 2014/30/EU (electromagnetic compatibility)
  - 2014/35/EU (Low Voltage Directive)
  - Class A EN 55022 (electromagnetic compatibility, conducted and radiated emissions)
- Connections: 2 x USB 2.0, 1 x HDMI, 2 x Ethernet (10/100/1000 Mb/s), 1 x COM RS-232 (default), RS-232/422/485 (non-isolated), 1 ground connection, 1 x GPIO, 1 power supply connector 24 V DC



Charging history of electric vehicles

### Connection to the charging stations

- Directly to the Ethernet LAN via a switch

### External network connection

- Directly to the Ethernet LAN or remotely via a 3G or 4G modem
- Communication under OCPP 1.6 JSON (possible upgrade to OCPP 2.0)

### Functions

- Calculates the power allocated to the charging stations
- Centralization and availability of data for each station

### User interface

EcoStruxure EV Charging Expert provides access to an ergonomic and intuitive user interface (web server) to:

- remote start / stop a charging session
- reset or reboot a charging station
- visualize a dashboard indicating the status of each charging station
- manage badges (local addition, import or export badge list) and user rights
- access and export the history of charging data by station, by badge or aggregated for the infrastructure
- consult and export maintenance data.



Current charging sessions

To download the latest release of EcoStruxure EV Charging Expert software, please scan or click on the following QR code:





## Practical information

### ➤ EcoStruxure EV Charging Expert dimensions (mm)

#### Dimensions

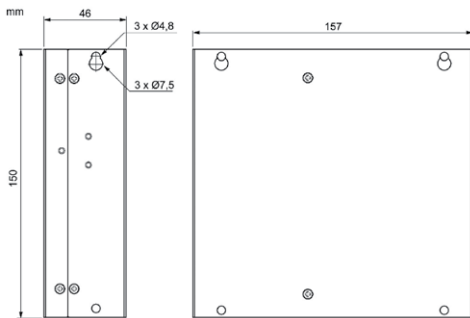

#### Rear view

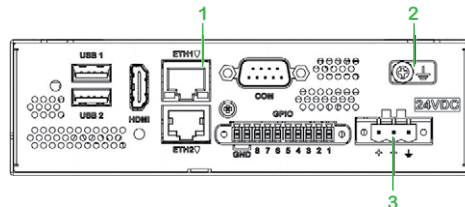

- 1- ETH1 (10/100/1000 Mbits/s)
- 2- Ground
- 3- DC supply

### ➤ CORE references<sup>(1)</sup>

		EcoStruxure EV Charging Expert with Static mode (dynamic load management with STATIC current setpoint)		EcoStruxure EV Charging Expert with Dynamic and Static modes (dynamic load management with DYNAMIC current setpoint, or STATIC current setpoint)			
References		HMIBSCEA53D1ESS	HMIBSCEA53D1ESM	HMIBSCEA53D1EDB	HMIBSCEA53D1EDS	HMIBSCEA53D1EDM	HMIBSCEA53D1EDL
<b>Features</b>							
Capacity	Number of EVlink charging stations	15	50	5	15	50	100
Multi zone	Maximum number of zones	1	10	2	2	10	20
	Maximum number of zone levels	1	4	2	2	4	4
Power management	Dynamic, with a STATIC current setpoint	✓	✓	✓	✓	✓	✓
	Time of use / DI	✓	✓	✓	✓	✓	✓
Other loads	Power consumption reporting on other feeders	✓	✓	✓	✓	✓	✓
Badge management	VIP privilege user badge	✓	✓	✓	✓	✓	✓
Station management	VIP privilege charging station	✓	✓	✓	✓	✓	✓

(1) To upgrade from a current CORE reference to an upper-level one, consult the UPGRADES Software references below.

### ➤ UPGRADES Software references

Upgrade from a CORE offer to an upper-level in case of increased number of charging stations in the infrastructure or load management mode change.

Reference	Description
EVLMSSESS2ESM	Upgrade EV Charging Expert static from 15 to 50 charging stations
EVLMSSEDB2EDS	Upgrade EV Charging Expert dynamic from 5 to 15 charging stations
EVLMSSEDB2EDM	Upgrade EV Charging Expert dynamic from 5 to 50 charging stations
EVLMSSEDB2EDL	Upgrade EV Charging Expert dynamic from 5 to 100 charging stations
EVLMSSEDS2EDM	Upgrade EV Charging Expert dynamic from 15 to 50 charging stations
EVLMSSEDS2EDL	Upgrade EV Charging Expert dynamic from 15 to 100 charging stations
EVLMSSEDM2EDL	Upgrade EV Charging Expert dynamic from 50 to 100 charging stations
EVLMSSESS2EDS	Upgrade EV Charging Expert 15 charging stations from static to dynamic
EVLMSSESS2EDM	Upgrade EV Charging Expert from 15 charging stations static to 50 charging stations dynamic
EVLMSSESM2EDM	Upgrade EV Charging Expert from 50 charging stations static to 50 charging stations dynamic
EVLMSSESS2EDL	Upgrade EV Charging Expert from 15 charging stations static to 100 charging stations dynamic
EVLMSSESM2EDL	Upgrade EV Charging Expert from 50 charging stations static to 100 charging stations dynamic

#### Additional information

##### Range compatibility:

EVlink Pro AC  
EVlink Pro DC 120 -180 kW  
EVlink Smart Wallbox  
EVlink Parking

Technical documentation

Please refer to bibliography in Appendix

[Discover more installation guidelines for EcoStruxure EV Charging Expert](#)

# EcoStruxure™ EV Charging Expert



## ➤ Features and benefits

Simplified, decentralized, flexible installation architecture



- Available in different versions from 5 to up to 100 charging stations from one single user interface dashboard
- Manages several parking zones each one with its own power metering for dynamic load management. It is scalable from a current model to a more sophisticated one
- Operates with open protocols (OCPP 1.6Jjson) facilitating integration with other systems
- Supports energy local production to extend charging capacities

Designed to be easily installed and commissioned by an installer



- Protection and control components to be installed in a Prisma panel or equivalent
- The webserver includes a configuration assistant that walks the installer through the different steps to configure the system
- Automatic scan and configuration of charging stations
- Easy firmware updates, with the most recent firmware release available on se.com.

Multiple functionalities for efficient operation and maintenance



- Local supervision of charging stations and their power management
- Intuitive dashboard interface to manage and control the installation
- Time-of-use electricity tariff scheduling to limit EV charging when the electricity price is high, and to maximize it when it is low
- Visibility on charging with priority capabilities on the charging station (no or limited load-shed)
- User badges management when supervision is not part of system
- Historic data related to the EV charging transactions are registered for analytics, cost allocation or invoicing
- Compatible with a Charging Point Operator backend system (OCPP 1.6J protocol)
- Integration capabilities with the Building Management System (may require specific development using webservice)

## ➤ Functions performed by all commercial references of EV Charging Expert

Access Management	Commissioning	Operation	Connectivity
<p>▼</p> <p>Add, modify, delete, supervise badges</p>	<p>▼</p> <p>Commissioning all charging stations directly from EVlink LMS</p> <p>Save and restore commissioned configuration</p>	<p>▼</p> <p>Supervision through real-time dashboard and remote actions on charging stations</p> <p>Charge data report export</p> <p>Maintenance report export</p>	<p>▼</p> <p>Connection with CPO supervision (OCPP 1.6 Json)</p> <p>Connection with EcoStruxure supervision (web services)<sup>(1)</sup></p> <p>Optional: 3G/4G modem</p> <p>Commissioning by Ethernet cable</p>

(1) May require specific development



EcoStruxure EV Charging Expert has been awarded with the prestigious "Solar Impulse Efficient Solution" label.



[Find out more here](#)



Refer to Appendix for detailed

- > Switch details .....p. 83
- > Possible IT network topologies.....p. 82
- > Typical load management architectures.....p. 84





# EcoStruxure™ EV Advisor\*



EcoStruxure EV Advisor is an eMobility management platform that enables seamless EV charging for fleets, buildings and destinations.

This SaaS offer is built to supply charge point operators, installers, building operators and fleet operators with everything they need to make their operation a successful venture.

Users benefit from remote supervision and operation functions including features such as asset monitoring and asset control, cloud-based static load leveling, EV driver access management, pricing, EV Driver payment collection, roaming integration and credit card terminal integration.

As an open platform, EcoStruxure EV Advisor will enable businesses who operate EV charging infrastructure implement their individual business case using Schneider or third-party manufacturer's hardware\*.

This digital solution complements the eMobility portfolio and completes the EcoStruxure for eMobility offer.

## ➤ EcoStruxure EV Advisor: designed to meet your needs



### Interoperable

with certified OCPP1.6J charging stations and access to our extensive API library



### Convenient

excellent uptime and access to a large range of services



### Intuitive

Easy to use with advanced EV data management and analytics capabilities



### Cybersecurity

following General Data Protection Regulation and cybersecurity recommendations



### Flexible

with white-labeling options and add-ons to adapt to your use case



### EV Driver Friendly

with a trusted and intuitive EV driver app



### Add-on options (for Essential or Advanced package)

- + Roaming integration with Gireve, Hubject and Zapmap
- + Credit Card payment solution integration

- + API Integration
- + EV Driver Support 24/7\*

#### ADVANCED

- White-labeled EV driver application
- EV driver management with granular access control via RFID
- Flexible pricing with in-app payment and billing functionalities
- Dynamic pricing solution based on Nord Pool AS integration\*
- Reservation and eVoucher solution

#### ESSENTIAL

- White-labeled management platform
- Multiple layers to manage your customers and their different locations
- Charging station management with remote control and notifications
- Dashboard, reporting and data extract
- Load balancing solution

Each package introduces a selection of available features. Contact us for more information.

\* Available in selected European countries and subject to the service offered by Nord Pool AS.



## ➤ Supervise your Charging Infrastructure with EcoStruxure EV Advisor

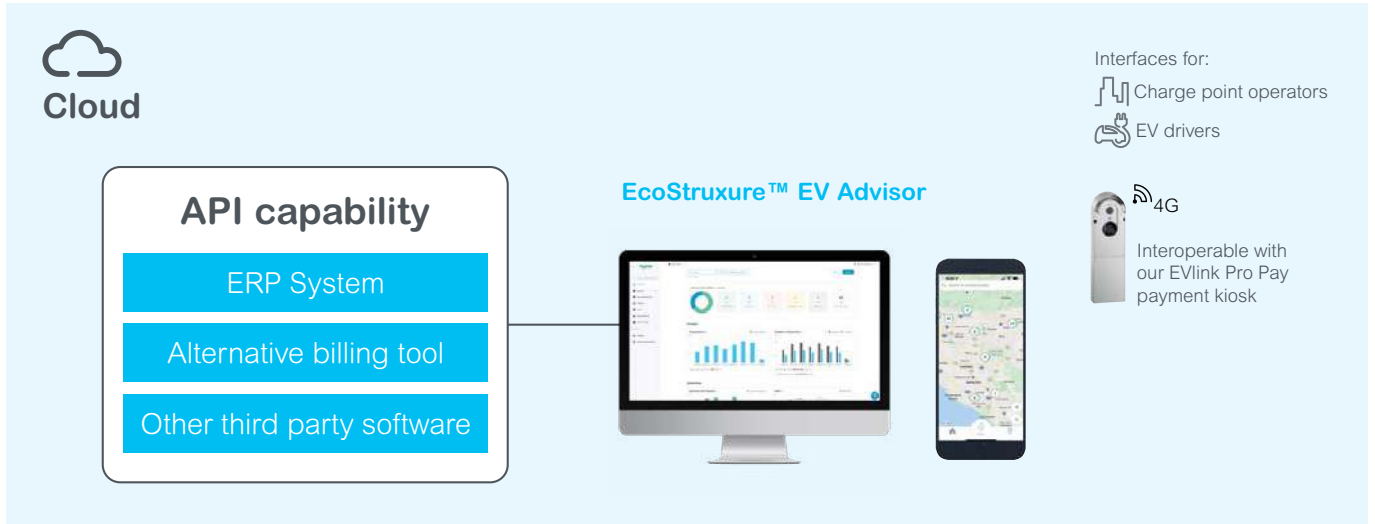

The charging infrastructure can be connected either via your local network or with a 4G modem connection\*.

**One or multiple sites**

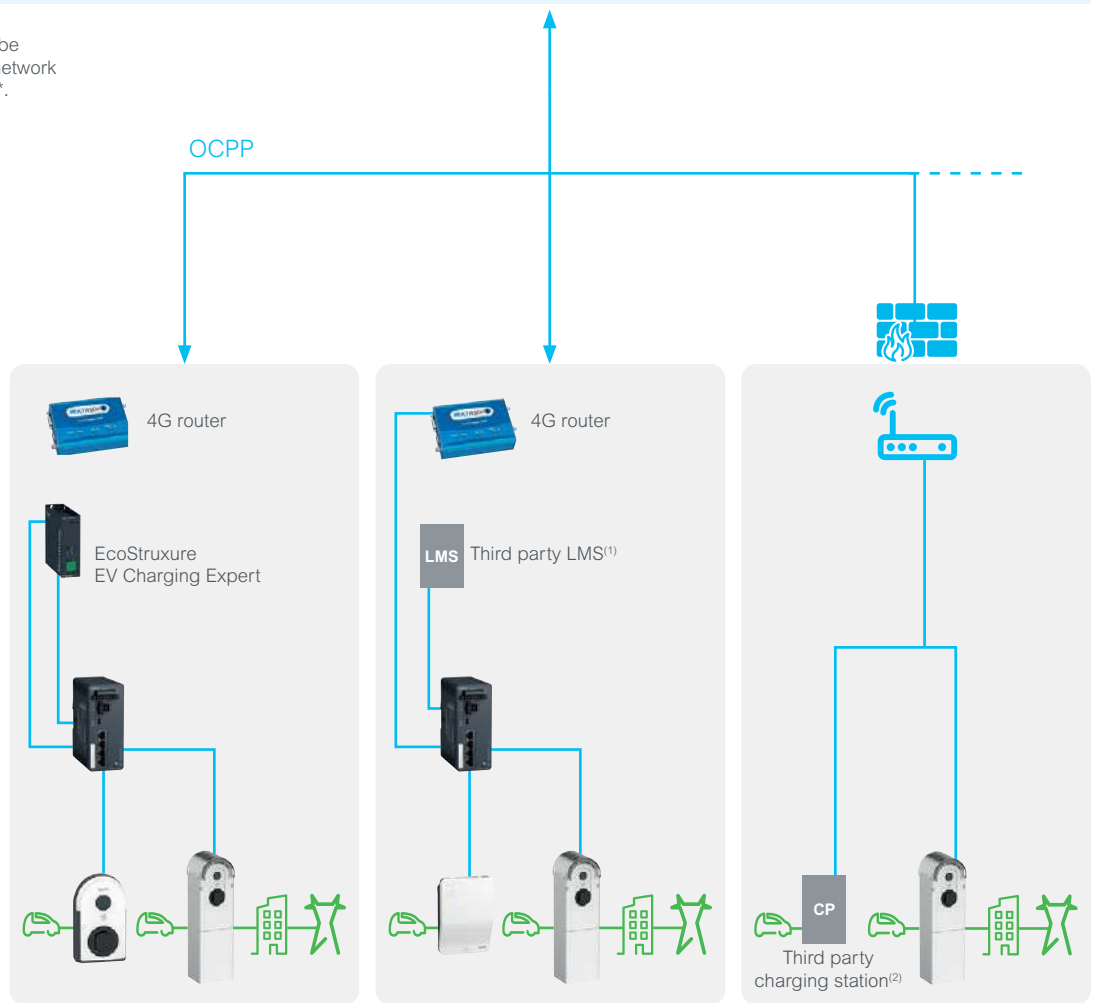

Examples of infrastructures

<sup>(1)</sup> 4G data subscription is to be provided by customer and not included in the solution.

<sup>(2)</sup> Consult us to get the list of approved third party charging station manufacturers.

\* Available in selected European countries.

# EcoStruxure™ EV Advisor



## › Features and benefits of EcoStruxure EV Advisor

Main dashboards of the cloud-based supervision system



Remote control

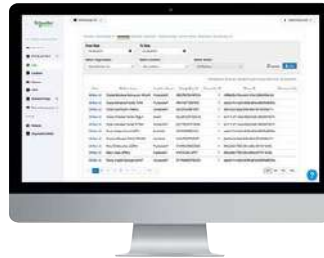

Detailed reports



Performance dashboard

### Manage your EV charging infrastructure



- Monitor your charging infrastructure remotely and carry out remote maintenance and troubleshooting activities
- Receive alerts and notifications in case your charging infrastructure behaves out of the ordinary

### Load balancing solution



- Optimize EV infrastructure energy consumption with the static cloud energy management feature
- Monitor usage of the EV infrastructure to size and anticipate future needs through stats and dashboards

### Flexible prices



- Set tariffs for charging events based on location, day of the week, time of day, session duration, consumption, number of charging events, and more

### Dynamic pricing solution integration\*,\*\*



- Let the platform automatically adjust the pricing policy using current rate data from the Nord Pool AS data base
- Fair pricing is applied and revenues are in line with cost of energy

### Payment and billing functionalities



- In-app payment\*\*
  - EV Drivers can use the app ad-hoc, or as a registered user with a configured payment method for their transactions
  - For registered EV drivers, choose to collect payment per transaction or on a monthly basis
- Integration of Credit Card Terminal: collect payments via credit card terminals and allow for a real ad-hoc experience

### Roaming platform integration



- Choose from the list of roaming network providers and enable public access to your charging stations.
- Allow external users to charge at your locations to increase utilization.

### Reservation and eVouchers\*\*



- Reduce EV driver's anxiety and enable better planning for your registered employees and tenants. Drivers may book a specific time slot during which they can charge. Penalties can be given if this tool is misused
- Hand out coupons for discounted charging at specific stations. Increase your attractiveness and improve EV Driver retention

These are some examples of features provided by EcoStruxure EV Advisor. Contact us to find out more.

\* Available only for specific geographies

\*\* Only available with Advanced offer package





KI. 2  
318 kV

Bolesta

Schneider  
Electric

1880

1880 KI. 2  
318 kV



Schneider  
Electric



# eMobility Services

eMobility Services.....	p. 62
How do I install and commission?.....	p. 63
How do I maintain? .....	p. 64
How do I optimize? .....	p. 65
A professional network .....	p. 65
Get in touch for support .....	p. 66
Commercial references.....	p. 67



# eMobility Services

## Services over the entire lifecycle

We support you wherever you are in your eMobility adoption.

## Our 4 service values

### Service-level agreement



By ordering a service contract, get advantage of an SLA, providing peace of mind by taking a better care for your EV Charging Infrastructure.

### Personalized deal



Leverage a contract individually tailored to your requirements and conditions.

### Increased lifespan of your equipment



Extend the lifespan of your products and systems with preventive maintenance and services.

### Schneider Electric expertise



Schneider Field Services representatives provide nationwide services with spare parts readily available for you.

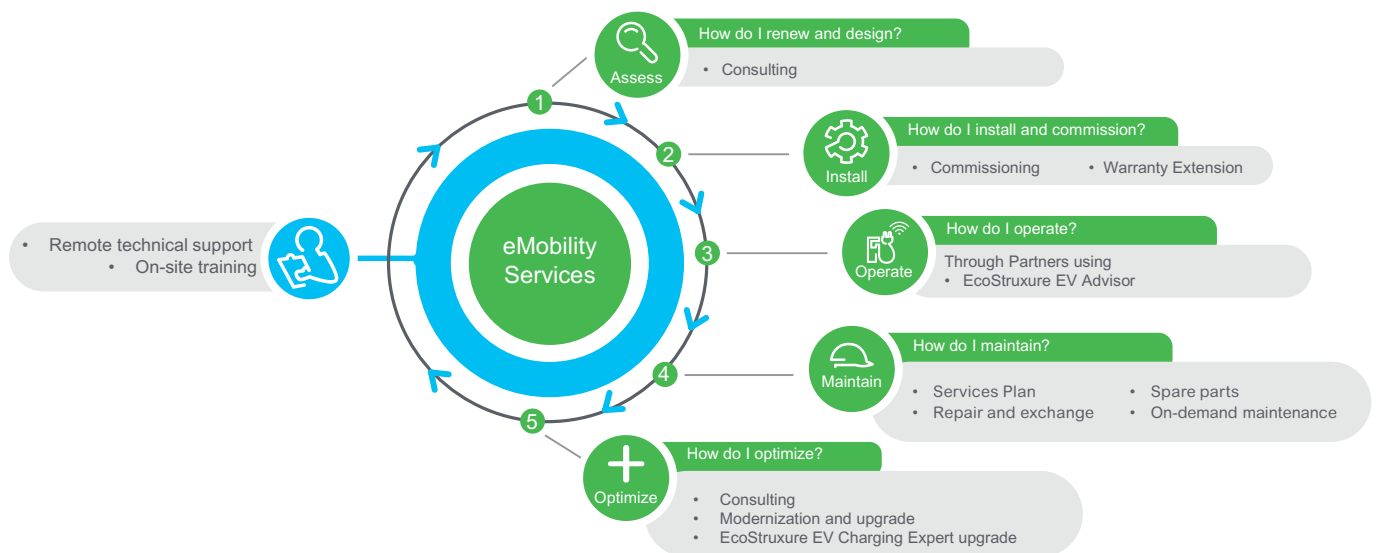

Contact your local eMobility sales representative for further information

# How do I install and commission?

## ➤ Commissioning

### For complex AC architectures with EcoStruxure EV Charging Expert, EVlink Pro AC or EVlink Pro DC

Our technical experts provide on-site and remote assistance in commissioning new charging station.

#### Benefits

- Minimize start-up time and improve end-user satisfaction.
- Take advantage of the expertise of Schneider Electric technicians on the choice of settings to improve system performance.
- Leverage an installation that complies with the Schneider Electric standard of practices and therefore optimizes equipment uptime and costs.



## Download the MySchneiderApp and Manage your eMobility Asset seamlessly!

### Manage the performance of your asset

- Manage the performance of your asset
- Anticipate any issues
- Technical support through FAQs and contact to the Customer care center



[Download the Application](#)

**REGISTER YOUR ASSET NOW**

## ➤ Warranty Extension

### Long-term protection of your asset with warranty extension

Our warranty extension\* allows you to expand your factory warranty for an additional one or three years, giving you more flexibility and peace of mind, and improved control of your maintenance budget.

#### Benefits

- Keep repair costs under control
- Reduce maintenance costs of new products installed
- Tap into coverage flexibility and choose either one or three years



\*The warranty extension can only be ordered at the time of purchasing your EVlink charging station.

Check warranty duration with your local sales representative and register the warranty extension by contacting our Customer Care center.

# How do I maintain?

## ➤ eMobility Service Plan

### Extend life and performance of your equipment with our Services Plan

At Schneider Electric, we believe that the time and cost associated with EV charging infrastructure should never be barriers to achieving sustainable goals.

#### Benefits

- Continuous support with 8/5 remote technical support
- Optimize investment and increase uptime
- Control your budget with one fixed yearly plan for all maintenance needs
- Operate in optimum conditions with high-end services and up-to-date features and firmwares.



Services Plan			
<b>Support to operations</b>	Access to mySchneider portal with chat, visibility of assets and warranty status, visits scheduling and reports		✓
	Premium Technical Support	Direct access to experts during business hours with Service Level Agreement on Initial response time	✓
		Scheduled Support Session with expert	✓
		Remote expertise thanks to remote connectivity	Optional
	On-site intervention	Service Level Agreement – subject to local execution capabilities	✓
On-site intervention cost		Preferential tariff	
<b>Replacement Parts</b>	Replacement parts	Spare parts cost	Preferential tariff
<b>Maintenance</b>	Preventive Maintenance	Yearly On-Site Preventive Maintenance	✓
	Warranty Extension	1 or 3 years warranty extension	Optional

## ➤ eMobility Spare Parts

### Maximize reliability and safeguard your maintenance needs with high quality original parts

Schneider Electric provides you with original, high-quality and fast delivered spare parts, always available from our local, regional and global stocks together with repair work when needed.

#### End of life policy

- Schneider Electric provides continuity of service for all withdrawn products.
- Withdrawn spare parts, accessories and charging stations are available for 5 years from the commercialization end date to replace or repair products.

## ➤ Learn more on Schneider Electric website



Spare part list on the website  
**EVlink Field services**

Technical documentation

Please refer to bibliography in Appendix



# How do I optimize?

## ➤ EcoStruxure EV Charging Expert Upgrade and commissioning package

### Extend the eMobility infrastructure

Schneider Electric technicians upgrade your EcoStruxure EV Charging Expert license to extend the charging station management capacity and/or to move to dynamic load management without buying new products. They also perform on-site commissioning for additional charging stations and update the EcoStruxure EV Charging Expert software settings.



## ➤ EVlink Parking modernization

### Extend asset lifetime by replacing the motherboard

The upgrade of the electronic board for the EVlink Parking Service provides full Electronic Board replacement in order to extend the lifetime of your assets, modernize your infrastructure and postpone CapEx investment.

# A professional network

## ➤ eMobility Partner Program

Schneider Electric eMobility certified experts lead the way towards adopting new technology and processes to deliver high-quality services to our customers.

By becoming part of our partner network, you will be at the forefront of smart charging technology and expand your reach.

Join our professional network of certified eMobility partners to engage in a continuous specialization path.



### Benefits

- Gain in-depth knowledge and expertise
- Access to innovative digital tools and technical support
- Co-branding that enables the growth of your business

## ➤ Mobile Apps for Partners

### Easy commissioning with eSetup

- Save time on installation and commissioning and access to the charge details and maintenance report.

### EcoStruxure Facility Expert

- Accurate planning of preventive maintenance tasks and interventions
- Greater visibility of your work by easily generated reports
- Details of activities undertaken during a given period
- A way to share information securely internally or externally



[Download the Application](#)



[Download the Application](#)

# Get in touch for support

## ➤ Customer care support

**As one of our partners and customers, you have access to our technical support!**

Schneider Electric offers bespoke remote support to help you improve your productivity by quickly resolving any technical issues related to your eMobility products, both for the hardware and software to answer any question one phone call away from you.

## ➤ Premium Support

Our Premium Support is a highly responsive service adapted to our most loyal customers.

It allows us to answer your technical questions faster, with a commitment to a timeframe for response according to a Service Level Agreement on Initial Respond Time, and suitable resources to resolve the issue at hand. It enables direct access to Advanced Support Agents with multi-channel communication (phone, email, and chat) together with exclusive access to MySchneiderPortal containing exclusive FAQ content.

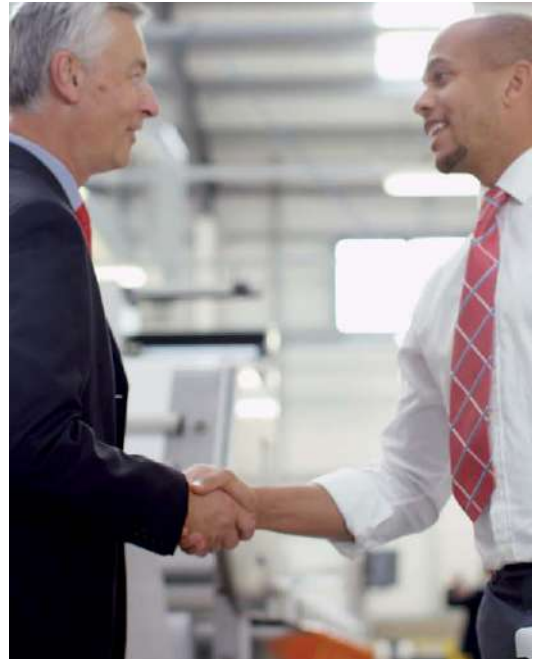

Reach out to our Customer Care team in your location

## ➤ eMobility Training

**Make the most of your staff's skills, giving them the resources to perform high-end services.**

Schneider Electric offers a wide selection of training solutions to enhance your competencies in the right area of expertise

Select your courses now on the technical training course finder



# Commercial references

## › Services dedicated to AC infrastructures

Warranty Extension		
Description	Product	Commercial reference
Additional 1-year Warranty Extension	EVlink Pro AC	EVS2W1B
Additional 3-year Warranty Extension	EVlink Pro AC	EVS2W3B

Training		
Description	Product	Commercial reference
Training AC infrastructure	Training on how to design AC charging Infrastructure	EVS1TBD
	Training on how to install & commission AC charging Infrastructure	EVS1TBIC
	Training on how to operate & maintain AC charging Infrastructure	EVS1TBOM

Commissioning		
Description	Product	Commercial reference
Remote assistance	Max. 5 EVlink Pro AC charging stations with EcoStructure EV Charging Expert	EVS1CR0L
	5 to 15 EVlink Pro AC charging stations with EcoStructure EV Charging Expert	EVS1CRSL
	Max. 5 EVlink Pro AC charging stations	EVS1CR0
	5 to 15 EVlink Pro AC charging stations	EVS1CRS
	Option: connection to a supervision solution	EVS1CRCPO
On-site	Max. 5 EVlink Pro AC charging stations with EcoStructure EV Charging Expert	EVS1CF0L
	5 to 15 EVlink Pro AC charging stations with EcoStructure EV Charging Expert	EVS1CFSL
	15 to 50 EVlink Pro AC charging stations with EcoStructure EV Charging Expert	EVS1CFML
	50 to 100 EVlink Pro AC charging stations with EcoStructure EV Charging Expert	EVS1CFLL
	Max. 5 EVlink Pro AC charging stations	EVS1CF0
	5 to 15 EVlink Pro AC charging stations	EVS1CFS
	15 to 50 EVlink Pro AC charging stations	EVS1CFM
	Option: connection to a supervision solution	EVS1CFCPO

Service Plan		
Description	Product	Commercial reference
Service Plan duration	1 year eMobility Service Plan	ECOESSEV1Y
	3 years eMobility Service Plan	ECOESSEV3Y
	5 years eMobility Service Plan	ECOESSEV5Y
Upgrade Preventive Maintenance	Yearly Preventive Maintenance EVlink Pro AC	ECOESSRVPAC
	Yearly Preventive Maintenance ecoStructure EV Charging Expert	ECOESSRVEVCE
Upgrade Warranty Extension	1 year Warranty Extension EVlink Pro AC	ECOESSPACWE
	1 year Warranty Extension ecoStructure EV Charging Expert	ECOESSEVCEWE
Upgrade FSR on-site dispatch Service Level Agreement (subject to local execution capabilities)	FSR dispatch 8H	ECOESSEVFSR8H
	FSR dispatch 12H	ECOESSEVFSR12H
	FSR dispatch Next Business Day	ECOESSEVFSRNBD
	FSR dispatch 48H	ECOESSEVFSR48H

Modernization		
Description	Product	Commercial reference
EVlink Parking modernization	Upgrade of main circuit board, for 1 charge point	EVS1UFP1B
	Upgrade of main circuit board, for 2 charge point	EVS1UFP2B

# Commercial references

## › Services dedicated to DC infrastructures

Training		
Description	Product	Commercial reference
Training on DC infrastructure	Training on EVlink Pro DC 180 kW – How to Install	EVS1TID100

Commissioning		
Description	Product	Commercial reference
Commissioning	On-Site Commissioning for 1 EVlink Pro DC ≥ 120 kW	EVS1CFD100

Service Plan		
Description	Product	Commercial reference
Service Plan duration	1 year eMobility Service Plan	ECOESSEV1Y
	3 years eMobility Service Plan	ECOESSEV3Y
	5 years eMobility Service Plan	ECOESSEV5Y
Upgrade Preventive Maintenance	Yearly Preventive Maintenance EVlink Pro DC	ECOESSPRV/PDC100
Upgrade Warranty Extension	1 year Warranty Extension EVlink Pro DC	ECOESSPDC100WE
	1 year Warranty Extension for Power Module	ECOESSPDCPMWE
Upgrade FSR on-site dispatch Service Level Agreement (subject to local execution capabilities)	FSR dispatch 8H	ECOESSEVFSR8H
	FSR dispatch 12H	ECOESSEVFSR12H
	FSR dispatch Next Business Day	ECOESSEVFSRNBD
	FSR dispatch 48H	ECOESSEVFSR48H
Upgrade site assessment	1 site assessment EVlink Pro DC 180 kW	ECOESSEVSAPD100

On-Demand Service		
Description	Product	Commercial reference
On-Demand preventive maintenance visit		EVS1PMD100



# Electrical Distribution for eMobility

Schneider Electric Power Distribution .....	p. 71
Acti9 Type A-SI or B: Residual Current Devices (RCD) .....	p. 72
ComPacT NSX and VigiPacT add-on: Earth leakage protection.....	p. 73
iMNx: undervoltage release tripping unit .....	p. 74
Metering solutions.....	p. 75
Decentralized EV distribution: Canalis™ .....	p. 77



# Schneider Electric Power distribution

Increasing use of Electric Vehicle will require an intense growth of charging infrastructure. The vehicle charging needs connection to an electricity supply, the question of electrical distribution is central. The so-called EVSE (electric vehicle supply equipment) are intended to be installed in various environments.

the International Electrotechnical Committee (IEC) defined a set of standards, covering devices for protection (short-circuit, electric shocks, overvoltage) and electrical installation standards.

Please refer to appendix

## ➤ Overview

<b>Electrical Protections</b>	 MCCB	 MCB	 RCD	 iMNx
<b>Energy Efficiency</b>	 Metering solutions			 EcoStruxure Panel Server
<b>Scalability</b>	 Canalis	 Kaedra	 Pragma	 PrismaSeT range



Learn more about  
**Electrical Distribution Solutions**

# Acti9 Type A-SI or B: Residual Current Devices (RCD)

## Electrical protections for residential or buildings applications

As the EV may reject DC residual current during charging, the selection of type of RCD shall be considered carefully.

- Type A RCD, complying to IEC 61008 or IEC 61009 series can be used in conjunction with an EVSE equipped with a Residual Direct Current Detecting Device (RDC-DD), complying to IEC 62955, intended to detect 6 mA DC residual current.
- Type B RCD provides protection against residual AC, pulsating DC and smooth DC residual currents. It provides also continuity of service in case of small DC residual currents.



Acti9 RCBO  
A9DB2616

### > Acti9 iCV40N Type A-SI

- **Helps protect people** against earth leakage currents from multifrequency components, generated by charging station technology that can cause fibrillation and electrocution.
- **Simplify operation** thanks to VisiSafe™ and VisiTrip™.
- **Monitor and control the electrical panel** with PowerTag and Smartlink auxiliaries.

Acti9 iCV40N RCBO Type A-SI is certified (IEC/EN 61008-2-1)



Acti9 iID B type  
A9Z51240

### > Acti9 iID B type for EV

- **Helps protect people** against multifrequency earth leakage currents, generated by charging station technology that can cause fibrillation and electrocution.
- **Be installed** in coordination with other upstream and parallel RCDs (refer to the Schneider Electric Residual Protection Device guide for coordination tables).

IEC 60364-7-722 standard requires a 30 mA residual current protection for direct contact.

Acti9 iID B type RCCB for EV is certified (IEC/EN 62423) and is fully compatible with EV charging stations for residential and tertiary applications.



# ComPacT NSX and VigiPacT add-on: Earth leakage protection



ComPacT NSX



VigiPacT  
LV432465

## > ComPacT NSX VigiPacT add-on

ComPacT NSX with VigiPacT Add and ComPacT NSX with Micrologic 4 & 7 are Residual Current Device (RCD) according to IEC 60947-2 Annex B with a sensitivity adjustable from 30mA to 30A.

RCD may be required for protection against electric shock in case of line to earth fault and/or protection against thermal effect caused by insulation fault, depending on local regulation and characteristics of the installation (e.g long cables).

Standards:

- IEC 60947-2, annex B
- IEC 60755, Type A, immunity to DC components up to 6 mA
- Operation down to -25 °C as per VDE 664



Learn more on  
**ComPacT NSX  
& NSXm  
Circuit Breakers**

## > Solution diagram

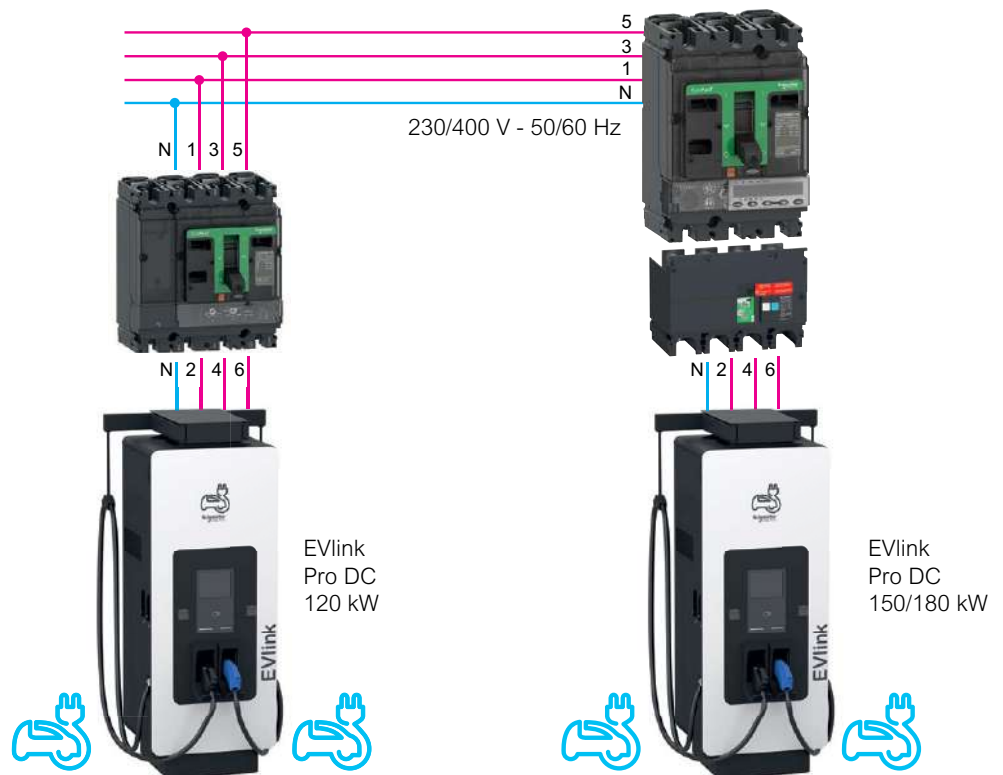

Current information and protections to use with EVlink Pro DC 120 - 150 - 180 kW			
Current			
Power	120 kW	150 kW	180 kW
Rated current	193 A	242 A	291 A
Max. current	214 A	268 A	323 A
Electrical protection			
Circuit breaker (overcurrent)	3P+N or 4P	3P+N or 4P	3P+N or 4P
References	C25F4TM250* or C25F44V2501*	C40F42D400	C40F42D400
Optional RCD protection (VigiPacT)	-	LV432465	LV432465

\*Optional RCD protection included.

Note: if there is plan to upgrade later (from 120 to 150 kW or 150 to 180 kW...) already consider the protection sizings for DC 180 kW.

# iMNx: undervoltage release tripping unit

Undervoltage release tripping unit to increase continuity of service and enhance people protection.

iMNx is an undervoltage release, independent from the supply voltage function which adds a second level of electrical protection.

Regardless of the RDC-DD 6 mA and in accordance with IEC60364-5-53 and EV Ready requirements, the MNx helps to protect people during intervention on electrical equipment and to increase continuity of service. IEC61851 ed3.0 §8.1 also recommends a monitoring solution to provide an isolating function.

Most of EVlink Pro AC charging stations have an embedded iMNx release.  
If not, iMNx can be supplied with the charging station.



## Acti9 iMNx, undervoltage release

<b>Commercial reference</b>	<b>A9A26969</b>
[Uc] control circuit voltage	220...240 V AC 50/60 Hz
Control type	With external feeding
9 mm pitches	2
Width	18 mm

For EVlink Pro AC commercial references with embedded protection

Please refer to page 27



# Metering solutions

## Metering solutions to display the active energy consumed.

- Maximize charging power in residential and small tertiary applications
- Provide a MID certified meter so that the payment and billing is linked to the amount of energy consumption
- Send active energy consumed information in OCPP to a supervision solution with communicating meters.

## › Standalone meters with external current transformers



METSEPM5320

### PowerLogic Power meter

Commercial reference	METSEPM5320
Communication	1 Ethernet port
Accuracy class	0.5 S
Dimensions	96 x 96 x 72 mm (H x W x D)
Consumption	130 mA / 24 V DC - 65 mA / PoE 48 V DC

To be completed with (not provided)

- a closed Current Transformer
- a cut-off device
- a short-circuiting block

PowerLogic PM5000 series power meters offer high-end cost management capabilities in a straightforward metering platform.



A9MEM3155

### iEM Energy meters - MID

Commercial reference	A9MEM3155
Communication	Modbus
Accuracy class	Class 1 active energy conforming to IEC 62053-21 Class 1 active energy conforming to IEC 61557-12 Class B active energy conforming to EN 50470-3

Width	90 mm
Poles description	3P+N 1P+N 3P

Acti9 iEM3000 series energy meters are cost-attractive, feature-rich energy meters for DIN rails and modular enclosures. More than just kWh meters, the Acti9 iEM3000 series meters provide a full overview of both energy consumption and on-site generation with full four-quadrant measurements of the active and reactive energy delivered and received.

# Metering solutions

## ➤ Circuit breakers with embedded metering

The Enerlin'X communication system provides access to device status, electrical values and control, using Ethernet and Modbus SL communication protocols.



Enerlin'X IFE  
LV434002

### Enerlin'X IFE switchboard server for ComPacT NSX circuit breaker

**Commercial reference** LV434002

Enerlin'X IFE provides an Ethernet interface to a ComPacT NSX circuit breaker when it has an embedded metering module

Electrical distribution	3-P, 4-P
Communication	Modbus TCP with circuit breaker
Metering	charging station energy consumption



MasterPacT MTZ with Micrologic Control unit



Enerlin'X EIFE  
LV851001

### Enerlin'X EIFE Embedded Ethernet interface for drawout MasterPacT MTZ

**Commercial reference** LV851001

Enerlin'X EIFE provides an embedded Ethernet interface to a MasterPacT circuit breaker with a Micrologic Control unit that can perform the charging stations metering

Electrical distribution	3-P, 4-P
Communication	Modbus TCP with circuit breaker
Metering	charging station energy consumption

## ➤ IoT gateway for an intelligent power network

EcoStruxure Panel Server is a modular gateway with enhanced cybersecurity that provides easy and fast connections to multiple concurrent edge control or cloud applications.



EcoStruxure Panel Server  
PAS600

### EcoStruxure Panel Server

**Commercial reference** PAS600 / PAS600L / PAS600T

Ethernet communication	2 Ethernet ports, type 10/100 Base: HTTPS, Modbus TCP/IP, SFTP, SNMP, ARP
Serial communication	1 serial port (RS485, 2 wires) – RS232 not supported Modbus serial protocol
Power supply	24 VDC, POE, 100-240 VACDC, 100-277 VACDC (different Panel Server references)
Consumption	3W max for 24 VDC – 5W max for 100-240 VACDC, 100-277 VACDC
Width	72 mm
Operating temperature	-25°C to +70°C



# Canalis™ : Decentralized EV distribution



## ➤ Canalis busbar trunking system

Decentralized EV charger electrical distribution with the Canalis™ busbar trunking system allows you to save time and cost on installation, and to be ready for future extensions.



Save space in your LV Switchboard and cost in the event of a change in the system\*:

- Installation in half the time compared with cables
- Future readiness



Decentralized distribution with Canalis is an optimized solution for indoor car parks and garages, bringing easy servicing and scalability. EVlink terminal distribution kits enable direct connection to the busbar.

\*Learn more: EV Charging Solutions for Residential and Commercial Buildings eBrochure 998-22207355

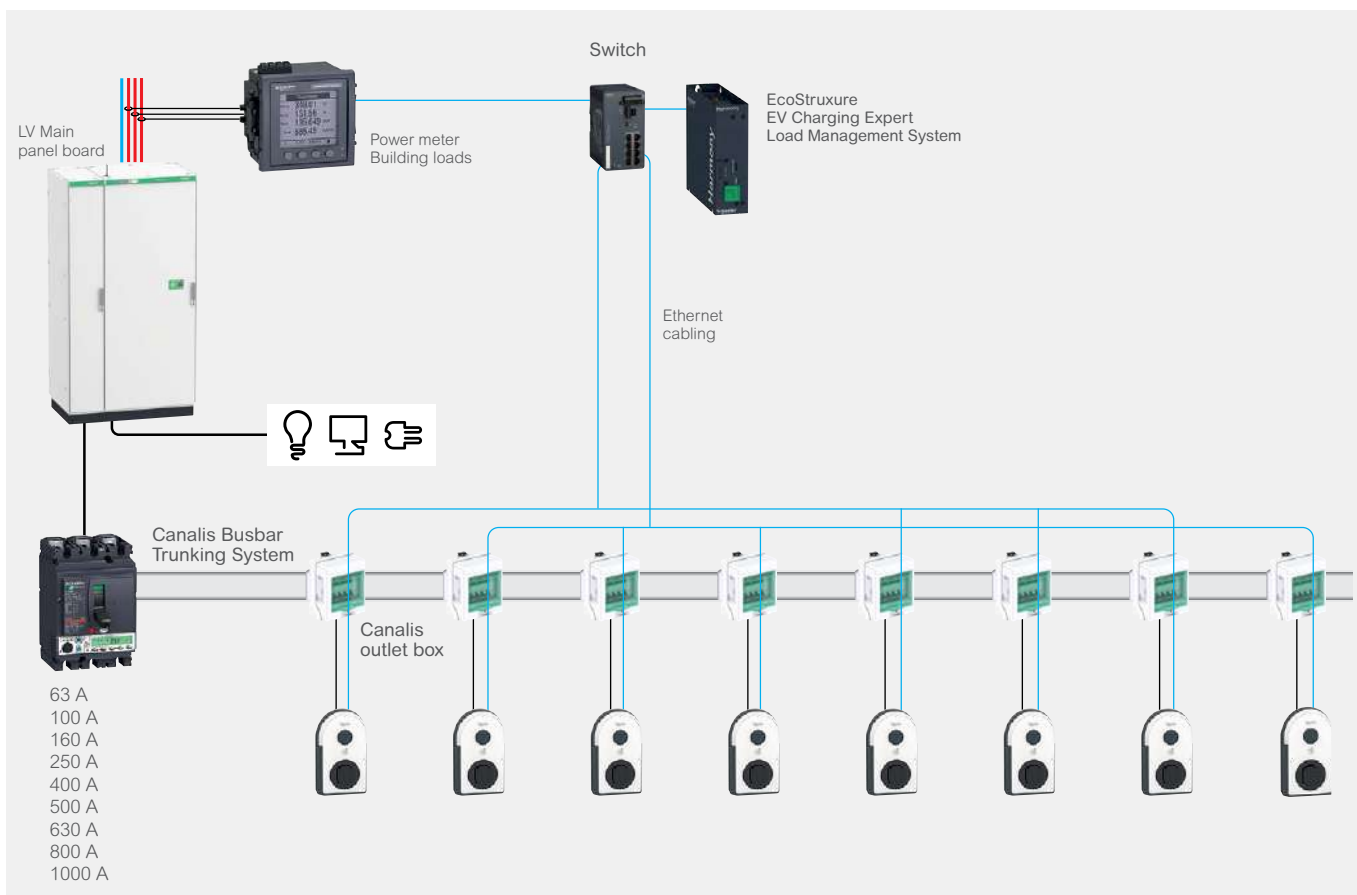



Schneider  
Electric



Learn more

Entde

Mobility



# Appendix

Electric Vehicle additional information .....	p. 80
How does it work?.....	p. 80
Electric Vehicle standards .....	p. 81
Communication network .....	p. 82
4G embedded modem .....	p. 82
4G embedded modem - EVlink Pro AC Cluster .....	p. 82
Wi-Fi communication - EVlink Pro DC .....	p. 82
Star topology .....	p. 83
Daisy chain topology .....	p. 83
EcoStruxure™ EV Charging Expert .....	p. 84
Static load management.....	p. 84
Dynamic load management.....	p. 85
List of commercial references .....	p. 87
Technical documentation .....	p. 92

# Electric Vehicle additional information

## > How does it work?

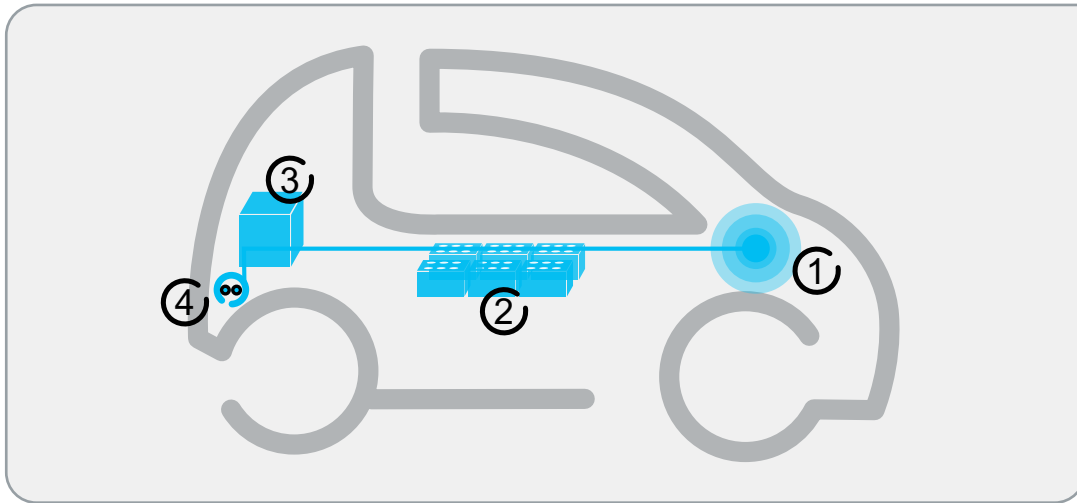

### 4 major components:

#### ① Motor

The vehicle has one or more motors. Depending on size and performance, the total power ranges between 15 and 200 kW.

Example: 48 kW (65 hp) for a small 4-seater sedan.

#### ② Batteries

Huge advances in battery technology have been made in recent years. Lead has gradually been replaced by other, more efficient compounds. Research continues with a view to improving capacity and reducing weight.

#### The most common technology at present is lithium-ion.

These new batteries have no memory effect and can therefore be charged without having to be completely empty **beforehand**. They are present in telephones, laptop computers, and some aircraft, as well as in electric vehicles.

#### ③ On-board charger

The vehicle is fitted with one battery charger supplied in AC by the charging station that defines the maximum charging current available. In some vehicles the battery charger may also be supplied in DC by the charging station.

#### ④ Charging inlet

The vehicle is fitted with at least one inlet for AC charging. In some vehicles, the inlet can also be used for DC fast charging or is completed by a second inlet for DC fast charging.



## > Learn more



Wiki Guide  
for electric vehicle  
charging



## ➤ Electric Vehicle standards

Charging an electric vehicle means connection to a powerful electricity supply. All electrical installations should be properly designed, constructed, and treated according to the IEC standards for EV installations.



The International Electrotechnical Committee (IEC) has defined a set of standards for EV infrastructure, covering devices, protection and electrical installation.

### IEC 61851 standard for EV supply equipment

This standard defines the fundamental aspects of EV charging and contains all the requirements covering the EVSE, as equipment. Therefore, the EVSE must comply with the IEC 61851 series and shall be supplied according to IEC 60364-7-722 Requirements.



Electric Vehicle Supply Equipment complying with IEC 61851-1 edition 3

### IEC 60364 -part 7-722 for Low Voltage installations

The international series of standards for Low Voltage Electrical Installations (IEC 60364 series) contains a new part dedicated to supplies for electric vehicles.

IEC 60364 part 7-722 requires electrical protective measures:

- **Protection against short-circuits and overloads with circuit breakers**
- **Protection against electric shocks and risks of electrocution with a 30 mA RCD.**

The RCD shall preferably be of type B, or possibly of type A in case the EVSE contains a 6 mA DC detection

- **Protection against overvoltage with a surge protection device (SPD)**



Acti9 iC60 circuit breaker



Acti9 B type Earth leakage protection



Acti9 Surge Protection Device

### IEC 61969-3 standard for enclosure installed outdoor

- IEC 61969-3 for outdoor enclosure (climatic, biological and chemical tests)
- IEC 60927-3-100 installation of electronic equipment
- IEC 62208 and UL50 Empty enclosures
- ISO12944 C4H Anti-corrosion

Class II Electrical protection (for Polyester enclosures)



PanelSet SF/SFN heavy duty outdoor enclosure



➤ Learn more



White Paper  
**Safety measures  
for electric vehicle  
charging**

# Communication network

## Possible IT network topologies

### ➤ 4G embedded modem

Each charging station is individually connected to the Charging Station Management System.

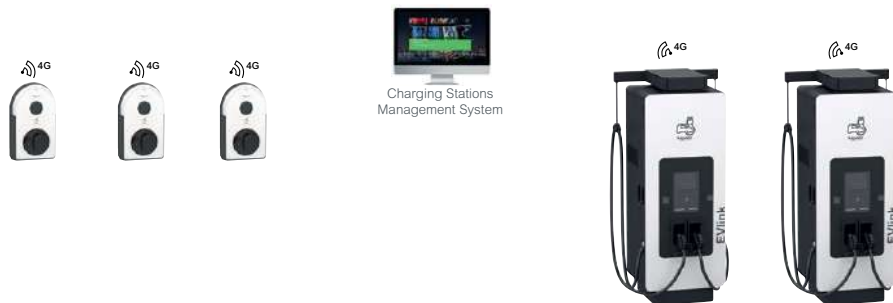

### ➤ 4G embedded modem - EVlink Pro AC Cluster

One charging station owns an embedded modem and shares 4G connectivity within a maximum of 9 other charging stations.

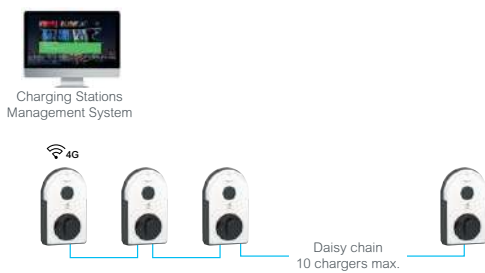

### ➤ Wi-Fi communication - EVlink Pro DC

This communication set-up requests a local Wi-Fi network.

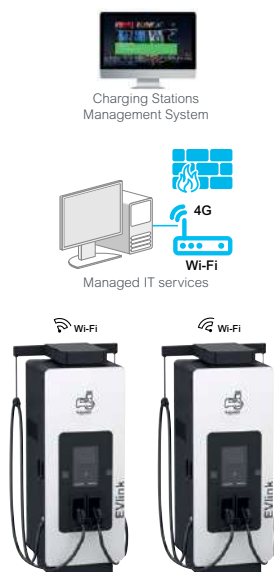

## ➤ Network topologies

### Star

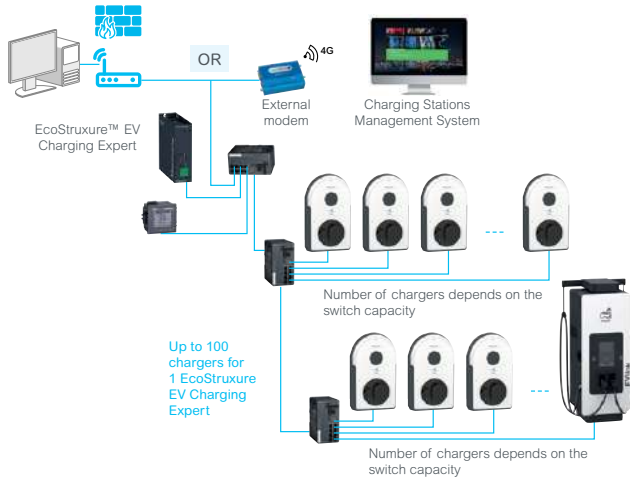

### Daisy chain

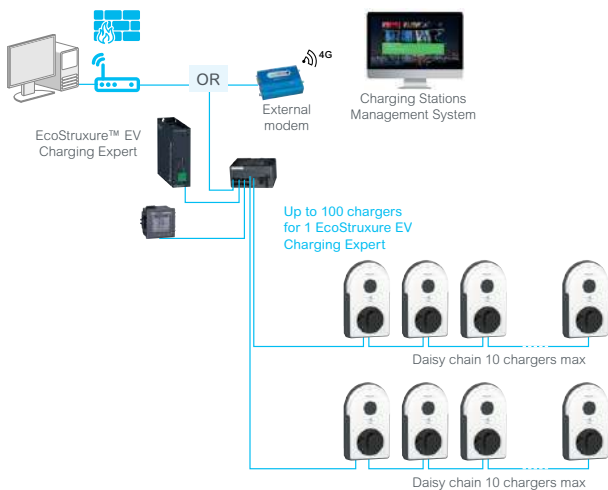

#### Modicon Managed and Unmanaged Switches

The Modicon Networking range offers you a smart and flexible way to integrate Ethernet solutions into your operation, from the device level to the control network and to your corporate network.

#### Unmanaged switch for star topology



4 ports for copper  
MCSESU053FN0



8 ports for copper  
MCSESU083FN0

#### Managed switch for ring and daisy chain topologies



4 ports for copper  
MCSESM043F23F0



8 ports for copper  
MCSESM083F23F0

These managed switches come with the Ethernet TCP/IP protocol. They come with 4 or 8 copper cable transmission ports. They provide simple and complex connectivity for multiple Ethernet devices, network management, enhanced cyber security and more advanced switching features.



Complete range  
of **Modicon Switches**

# EcoStruxure™ EV Charging Expert

## Typical load management architectures

### ➤ Static load management

#### Single-zone

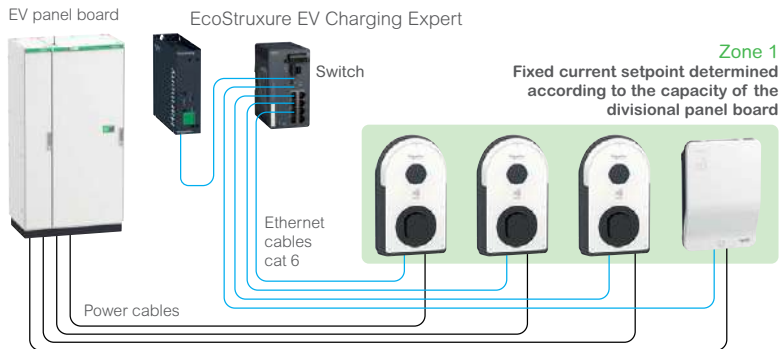

To select the right EcoStruxure EV Charging Expert commercial reference based on all available features, please check the selection table on page 53

#### EcoStruxure EV Charging Expert

- Up to 5 stations: ref. HMIBSCEA53EDB
- Up to 15 stations: ref. HMIBSCEA53D1ESS
- Up to 50 stations: ref. HMIBSCEA53D1ESM

#### Multi-zone (multiple switchboards)

EcoStruxure EV Charging Expert<sup>2</sup>

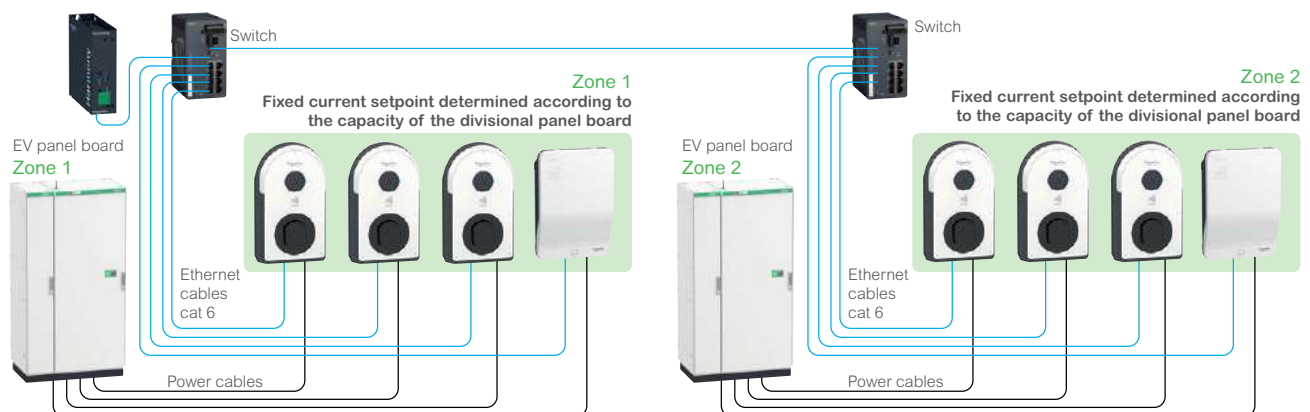

#### EcoStruxure EV Charging Expert

- From 1 to 5 stations in total, in a maximum of 2 zones: ref. HMIBSCEA53D1EDB
- From 1 to 15 stations in total in 1 single zone: ref. HMIBSCEA53D1ESS
- From 1 to 15 stations in total, in a maximum of 2 zones: ref. HMIBSCEA53D1EDS
- From 1 to 50 stations in total, in a maximum of 10 zones: ref. HMIBSCEA53D1ESM



## ➤ Dynamic load management

To select the right EcoStruxure EV Charging Expert commercial reference based on all available features, please check the selection table on page 53

### Multi zone<sup>(1)</sup>

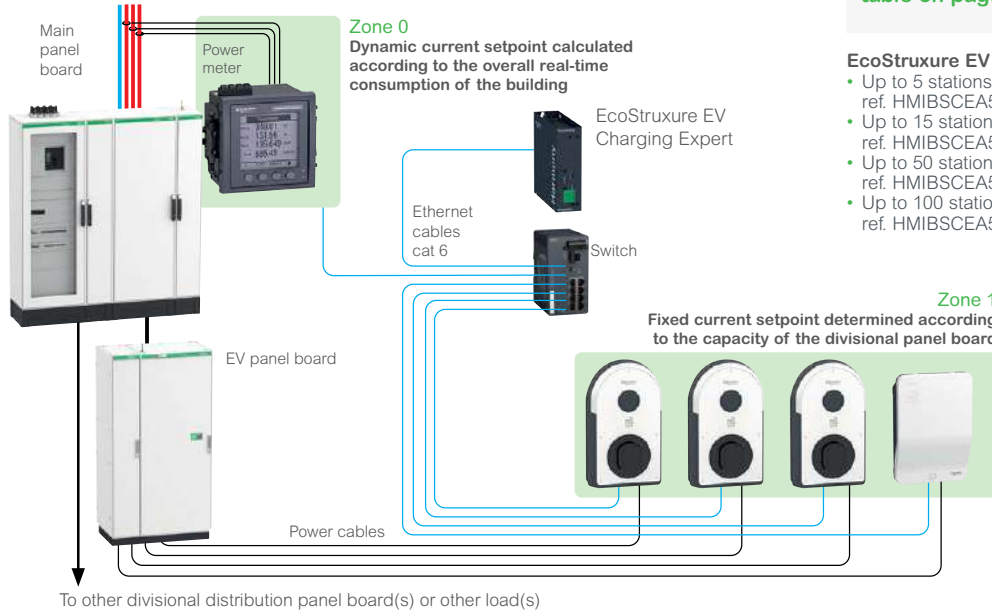

### EcoStruxure EV Charging Expert

- Up to 5 stations in a maximum of 2 zones: ref. HMIBSCEA53D1EDB
- Up to 15 stations in a maximum of 2 zones: ref. HMIBSCEA53D1EDS
- Up to 50 stations in a maximum of 10 zones: ref. HMIBSCEA53D1EDM
- Up to 100 stations in a maximum of 20 zones: ref. HMIBSCEA53D1EDL

### Multi zone<sup>(1)</sup>

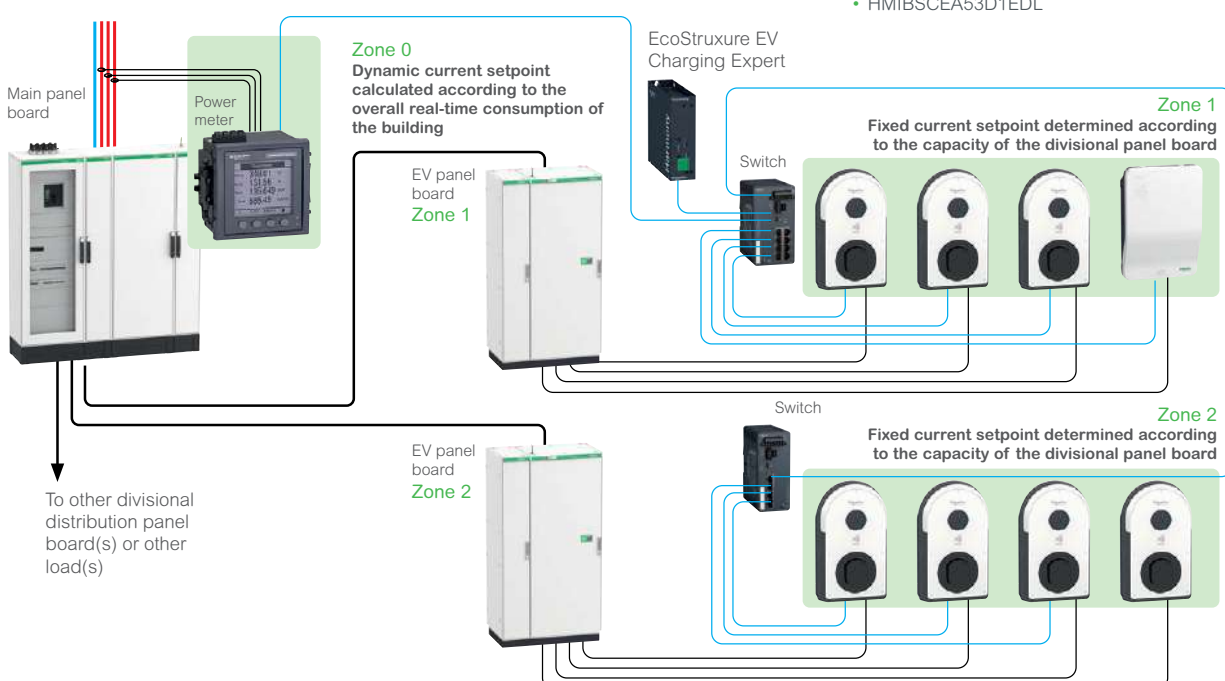

### EcoStruxure EV Charging Expert

- HMIBSCEA53D1EDM
- HMIBSCEA53D1EDL

(1) No more than 3 cascaded zones.

# EcoStruxure™ EV Charging Expert

## Typical load management architectures

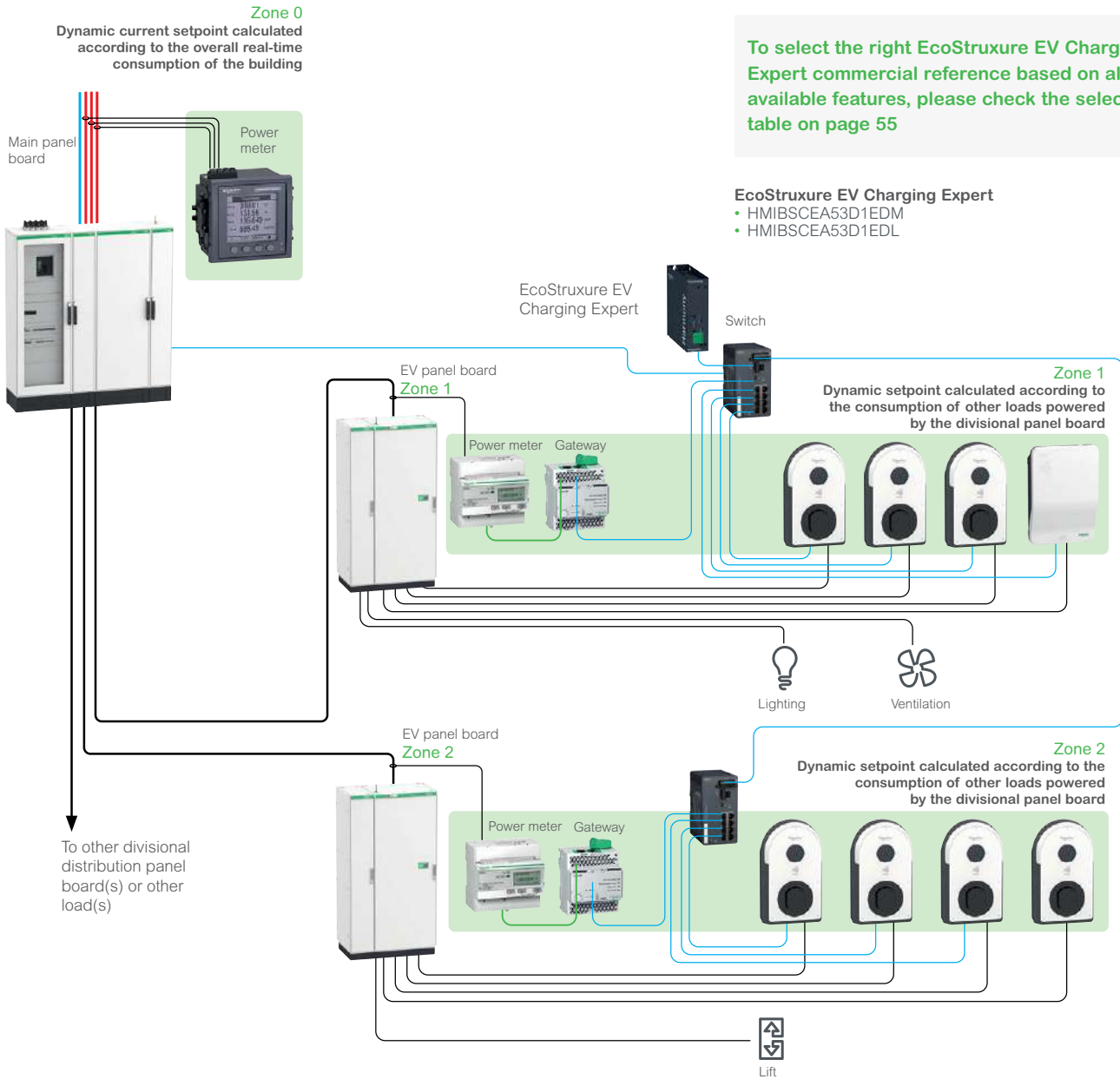

To select the right EcoStruxure EV Charging Expert commercial reference based on all available features, please check the selection table on page 55

### EcoStruxure EV Charging Expert

- HMIBSCEA53D1EDM
- HMIBSCEA53D1EDL

# List of commercial references

## Schneider Charge

Characteristics		References <sup>(1)</sup>
		<b>Schneider Charge</b>
<b>Charging stations with socket outlet</b>		
	7.4 kW (1P32A), 11 kW (3P 16A), 22 kW (3P 32A)	EVB3S07N4A
<b>Charging stations with attached cable 5 m and T2 connector</b>		
	7.4 kW (1P - 32 A)	EVB3S07N4AM
	11 kW (3P - 16 A)	EVB3S07N4EAM
<b>Charging stations with attached cable 7 m and T2 connector</b>		
	7.4 kW (1P - 32 A)	EVB3S07N40M
	11 kW (3P - 16 A)	EVB3S07N40EM
Characteristics		References <sup>(1)</sup>
		<b>Schneider Charge with TIC*</b>
<b>Charging stations with socket outlet</b>		
	7.4 kW (1P32A), 11 kW (3P 16A), 22 kW (3P 32A) (1P/3P+N)	EVB3S22N400F

\*Only for France

Accessories	References
<b>Peak controller</b>	
1 Phase anti-tripping module (peak controller from 16 A to 50A)	EVA4HPC1
1 Phase anti-tripping module (peak controller from 32 A to 100 A)	EVA2HPC1
3 Phase anti-tripping module (peak controller from 16A to 50A)	EVA2HPC3
<b>Gun Holder</b>	
Schneider Charge Gun Holder	EVA5GH

## EVlink™ Pro AC and Pro AC Metal

Characteristics	References
<b>Charging stations with socket outlet</b>	
EVlink Pro AC 7.4 kW 32 A 1PH T2S SOCKET 6 mA RCD Type Asi MNX	EVB3S07N4A
EVlink Pro AC 7.4 kW 32 A 1PH T2S SOCKET 6 mA RCD Type Asi MNX MID	EVB3S07N4AM
EVlink Pro AC 7.4 kW 32 A 1PH T2S TE SOCKET 6 mA RCD Type Asi MNX MID	EVB3S07N4EAM
EVlink Pro AC 7.4 kW 32 A 1PH T2S TE SOCKET 6 mA RCD Type Asi MNX	EVB3S07N4EA
EVlink Pro AC 7.4 kW 32 A 1PH T2S SOCKET 6 mA MNX MID	EVB3S07N40M
EVlink Pro AC 7.4 kW 32 A 1PH T2S TE SOCKET 6 mA MNX MID	EVB3S07N40EM
EVlink Pro AC 11 kW 16 A 3PH T2S SOCKET 6 mA RCD Type Asi MNX	EVB3S11N4A
EVlink Pro AC 11 kW 16 A 3PH T2S TF SOCKET RCD Type B EV MNX	EVB3S11N4FB
EVlink Pro AC 22 kW 32 A 3PH T2S SOCKET RCD Type B EV MNX	EVB3S22N4B
EVlink Pro AC 22 kW 32 A 3PH T2S SOCKET 6 mA RCD Type Asi MNX	EVB3S22N4A
EVlink Pro AC 22 kW 32 A 3PH T2S TE SOCKET 6 mA RCD Type Asi 30 mA MNX	EVB3S22N4EA
EVlink Pro AC 22 kW 32 A 3PH T2S TE SOCKET RCD Type B EV MNX	EVB3S22N4EB
EVlink Pro AC 22 kW 32 A 3PH T2S TF SOCKET RCD Type B EV MNX	EVB3S22N4FB
EVlink Pro AC 22 kW 32 A 3PH T2S SOCKET MID 6 mA and MNX supplied	EVB3S22N40M
EVlink Pro AC 22 kW 32 A 3PH T2S TE SOCKET MID 6 mA and MNX supplied	EVB3S22N40EM
EVlink Pro AC 22 kW 32 A 3PH T2S TF SOCKET MID 6 mA and MNX supplied	EVB3S22N40FM
EVlink Pro AC 22 kW 32 A 3PH T2S SOCKET 6 mA MNX	EVB3S22N4
EVlink Pro AC 22 kW 32 A 3PH T2S TE SOCKET 6 mA MNX	EVB3S22N4E
EVlink Pro AC 22 kW 32 A 3PH T2S SOCKET MID and RCD B EV MNX supplied (recommended for Metallic kit)	EVB3S22N40MR
EVlink Pro AC 7.4 kW 32 A 1PH T2S SOCKET 6 mA	EVB3S07N41
EVlink Pro AC 7.4 kW 32 A 1PH T2S TE SOCKET 6 mA	EVB3S07N4E1
EVlink Pro AC 22 kW 32 A 3PH T2S SOCKET 6 mA	EVB3S22N41
EVlink Pro AC 22 kW 32 A 3PH T2S TE SOCKET 6 mA	EVB3S22N4E1
<b>Charging stations with attached cable</b>	
EVlink Pro AC 7.4 kW 32 A 1PH Attached Cable 6 mA RCD Type Asi MNX	EVB3S07NCA
EVlink Pro AC 7.4 kW 32 A 1PH Attached Cable 6 mA RCD Type Asi MNX MID	EVB3S07NCAM
EVlink Pro AC 7.4 kW 32 A 1PH Attached Cable 6 mA RCD-DD and MNX supplied	EVB3S07NC0
EVlink Pro AC 22 kW 32 A 3PH Attached Cable 6 mA RCD-DD and MNX supplied	EVB3S22NC0
EVlink Pro AC 11 kW 16 A 3PH Attached Cable 6 mA RCD Type Asi MNX	EVB3S11NCA
EVlink Pro AC 22 kW 32 A 3PH Attached Cable 6 mA RCD Type Asi MNX	EVB3S22NCA
EVlink Pro AC 22 kW 32 A 3PH Attached Cable RCD Type B EV MNX	EVB3S22NCB
EVlink Pro AC 22 kW 32 A 3PH Attached Cable MID 6 mA and MNX supplied	EVB3S22NC0M

(1) References to be defined and local availability to be checked by Schneider Electric front offices.

# List of commercial references

## EVlink™ Pro AC and Pro AC Metal

Accessories	References <sup>(1)</sup>
Pack of 10 RFID Badges	EVP1BNS
Cable holder for EVlink Pro AC Metal charger	EVA1FWHS12
Permanent T2S socket cable holder EVlink Pro AC	EVA1PLS1
<b>Pedestal</b>	
Pedestal for 1 EVlink Pro AC Charger	EVA1PBS1
Pedestal for 2 EVlink Pro AC Chargers	EVA1PBS2
Plate to convert Pedestal for 1 charger to Pedestal for 2 EVlink Pro AC	EVA1PCS2
<b>Metallic kits</b>	
EVlink Pro AC Metal wall mount 1 charge point kit	EVA1RWKS1
EVlink Pro AC Metal floor standing 1 charge point kit	EVA1RFKS1
EVlink Pro AC Metal floor standing 2 charge points kit	EVA1RFKS2
<b>Enclosures</b>	
Thalassa PLS box kit IP66 power cable 25 35 <sup>2</sup>	EVA1RFKES
<b>Communication interface</b>	
4G kit - embedded modem with 2 internal antennas for EVlink Pro AC	EVA1MS
4G kit - embedded 4G modem with an external antenna for EVlink Pro AC Metal	EVA1MM
Smart meter connection Historical Standard TIC tele information client card EVlink Pro AC	EVA1MTH
<b>EVlink Pro PAY payment kiosk</b>	
Payment kiosk for EV charging installations	EVP1PROPAY

Charging cables	References
<b>EVlink charging cables</b>	
T2-T2 plug connector 32 A 1 Phase 5 m length	EVP1CNS32122
T2-T2 plug connector 32 A 1 Phase 7 m length	EVP1CNL32122
T2-T2 plug connector 32 A 1 Phase 10 m length	EVP1CNX32122
T2-T2 plug connector 32 A 3 Phase 5 m length	EVP1CNS32322
T2-T2 plug connector 32 A 3 Phase 7 m length	EVP1CNL32322
T2-T2 plug connector 32 A 3 Phase 10 m length	EVP1CNX32322

EVlink Pro AC Spare parts	References
<b>Front panel</b>	
SE white front plate	EVP1SS
SE white front plate with cut-out window	EVP1SM
<b>Socket outlet</b>	
1PH socket outlet T2S	EVP1SSS41
3PH socket outlet T2S	EVP1SSS43
1PH socket outlet T2S and Domestic TE	EVP1SSS51
3PH socket outlet T2S and Domestic TE	EVP1SSS53
1PH socket outlet T2S Domestic TF	EVP1SSS61
3PH socket outlet T2S Domestic TF	EVP1SSS63
TE domestic socket	EVP1SSSE
TF domestic socket	EVP1SSSF
<b>Attached cable</b>	
T2 attached cable 3PH 32 A 5 meter length	EVP1CSS323C
T2 attached cable 1PH 32 A 5 meter length	EVP1CSS321C

(1) References to be defined and local availability to be checked by Schneider Electric front offices.



# List of commercial references

## EVlink™ Pro AC and Pro AC Metal

Services	References <sup>(1)</sup>
<b>EVlink Pro AC - Warranty extension</b>	
Additional 1-year Warranty Extension for EVlink Pro AC	EVS2W1B
Additional 3-year Warranty Extension for EVlink Pro AC	EVS2W3B
<b>Training</b>	
Training on how to design AC charging Infrastructure	EVS1TBD
Training on how to install & commission AC charging Infrastructure	EVS1TBIC
Training on how to operate & maintain AC charging Infrastructure	EVS1TBOM

Comissioning	References <sup>(1)</sup>
<b>Remote assistance</b>	
Max. 5 EVlink Pro AC charging stations with EcoStruxture EV Charging Expert	EVS1CR0L
5 to 15 EVlink Pro AC charging stations with EcoStruxture EV Charging Expert	EVS1CRSL
Max. 5 EVlink Pro AC charging stations	EVS1CR0
5 to 15 EVlink Pro AC charging stations	EVS1CRS
Option: connection to a supervision solution	EVS1CRCPO
<b>On-site</b>	
Max. 5 EVlink Pro AC charging stations with EcoStruxture EV Charging Expert	EVS1CF0L
5 to 15 EVlink Pro AC charging stations with EcoStruxture EV Charging Expert	EVS1CFSL
15 to 50 EVlink Pro AC charging stations with EcoStruxture EV Charging Expert	EVS1CFML
50 to 100 EVlink Pro AC charging stations with EcoStruxture EV Charging Expert	EVS1CFLL
Max. 5 EVlink Pro AC charging stations	EVS1CF0
5 to 15 EVlink Pro AC charging stations	EVS1CFS
15 to 50 EVlink Pro AC charging stations	EVS1CFM
Option: connection to a supervision solution	EVS1CFCPO

Service Plan	References <sup>(1)</sup>
<b>Service Plan duration</b>	
1 year eMobility Service Plan	ECOESSEV1Y
3 years eMobility Service Plan	ECOESSEV3Y
5 years eMobility Service Plan	ECOESSEV5Y
<b>Upgrade Preventive Maintenance</b>	
Yearly Preventive Maintenance EVlink Pro AC	ECOESSPRVPAC
Yearly Preventive Maintenance EcoStruxure EV Charging Expert	ECOESSPRVEVCE
<b>Upgrade Warranty Extension</b>	
1 year Warranty Extension EVlink Pro AC	ECOESSPACWE
1 year Warranty Extension EcoStruxure EV Charging Expert	ECOESSEVCEWE
<b>Upgrade FSR on-site dispatch Service Level Agreement (subject to local execution capabilities)</b>	
FSR dispatch 8H	ECOESSEVFSR8H
FSR dispatch 12H	ECOESSEVFSR12H
FSR dispatch Next Business Day	ECOESSEVFSRNBD
FSR dispatch 48H	ECOESSEVFSR48H

Modernization	References <sup>(1)</sup>
<b>EVlink Parking modernization</b>	
Upgrade of main circuit board, for 1 charge point	EVS1UFP1B
Upgrade of main circuit board, for 2 charge point	EVS1UFP2B

(1) References to be defined and local availability to be checked by Schneider Electric front offices.

# List of commercial references

## EVlink™ Pro DC 120-150-180 kW

Characteristics	References
<b>Charging Stations</b>	
EVLINK Pro DC 120 kW DC CCS Combo 2 + CCS Combo 2; 3.6 meters range; with cable management	EVD1S120TBB
EVLINK Pro DC 120 kW DC CHAdeMO + CCS Combo 2; 3.6 meters range; with cable management	EVD1S120THB
EVLINK Pro DC 150 kW DC CCS Combo 2 + CCS Combo 2; 3.6 meters range; with cable management	EVD1S150TBB
EVLINK Pro DC 150 kW DC CHAdeMO + CCS Combo 2; 3.6 meters range; with cable management	EVD1S150THB
EVLINK Pro DC 180 kW DC CCS Combo 2 + CCS Combo 2; 3.6 meters range; with cable management	EVD1S180TBB
EVLINK Pro DC 180 kW DC CHAdeMO + CCS Combo 2; 3.6 meters range; with cable management	EVD1S180THB
EVLINK Pro DC 120 kW DC CCS Combo 2 + CCS Combo 2; 7.5 meters range; without cable management	EVD1S120TBBC7
EVLINK Pro DC 150 kW DC CCS Combo 2 + CCS Combo 2; 7.5 meters range; without cable management	EVD1S150TBBC7
EVLINK Pro DC 180 kW DC CCS Combo 2 + CCS Combo 2; 7.5 meters range; without cable management	EVD1S180TBBC7
<b>Accessories</b>	
Pack of 10 RFID Badges	EVP1BNS

## EVlink™ Pro DC 120-150-180 kW Services

Training	References
<b>Training on DC infrastructure</b>	
Training on EVlink Pro DC 180 kW – How to Install	EVS1TID100
<b>Commissioning</b>	
<b>On site</b>	
For 1 EVlink Pro DC ≥ 120 kW	EVS1CFD100
<b>Service Plan</b>	
<b>Service Plan duration</b>	
1 year eMobility Service Plan	ECOESSEV1Y
3 years eMobility Service Plan	ECOESSEV3Y
5 years eMobility Service Plan	ECOESSEV5Y
<b>Upgrade Preventive Maintenance</b>	
Yearly Preventive Maintenance Pro DC 180 kW (must be sold with any of the Service plan reference)	ECOESSRPVDC100
<b>Upgrade Warranty Extension</b>	
1 year Warranty Extension Pro DC 180 kW	ECOESSPDC100WE
1 year Warranty Extension for Power Module	ECOESSPDCPMWE
<b>Upgrade FSR on-site dispatch Service Level Agreement (subject to local execution capabilities)</b>	
FSR dispatch 8H	ECOESSEVFSR8H
FSR dispatch 12H	ECOESSEVFSR12H
FSR dispatch Next Business Day	ECOESSEVFSRNBD
FSR dispatch 48H	ECOESSEVFSR48H
<b>Upgrade site assessment</b>	
1 site assessment EVlink Pro DC 180 kW	EVS1PMD100

(1) References to be defined and local availability to be checked by Schneider Electric front offices.

# List of commercial references

## EcoStruxure™ EV Charging Expert

Characteristics	References <sup>(1)</sup>
<b>Core</b>	
EV Charging Expert Core 5 CS dynamic	HMIBSCEA53D1EDB
EV Charging Expert Core 15 CS dynamic	HMIBSCEA53D1EDS
EV Charging Expert Core 50 CS dynamic	HMIBSCEA53D1EDM
EV Charging Expert Core 15 CS static	HMIBSCEA53D1ESS
EV Charging Expert Core 50 CS static	HMIBSCEA53D1ESM
EV Charging Expert Core 100 CS dynamic	HMIBSCEA53D1EDL
<b>Upgrade</b>	
EV Charging Expert Upgrade dynamic 5 CS to 15 CS	EVLMSedb2EDS
EV Charging Expert Upgrade dynamic 5 CS to 50 CS	EVLMSedb2EDM
EV Charging Expert Upgrade dynamic 5 CS to 100 CS	EVLMSedb2EDL
EV Charging Expert Upgrade 15 CS from static to dynamic	EVLMSess2EDS
EV Charging Expert Upgrade static from 15 CS to 50 CS	EVLMSess2ESM
EV Charging Expert Upgrade from 15 CS static to 50 CS dynamic	EVLMSess2EDM
EV Charging Expert Upgrade dynamic from 15 CS to 50 CS	EVLMSeds2EDM
EV Charging Expert Upgrade from 15 CS static to 100 CS dynamic	EVLMSess2EDL
EV Charging Expert Upgrade dynamic from 15 CS to 100 CS	EVLMSeds2EDL
EV Charging Expert Upgrade from 50 CS static to 50 CS dynamic	EVLMSesm2EDM
EV Charging Expert Upgrade static 50 CS to dynamic 100 CS	EVLMSesm2EDL
EV Charging Expert Upgrade dynamic from 50 CS to 100 CS	EVLMSedm2EDL

(1) References to be defined and local availability to be checked by Schneider Electric front offices.

# Bibliography

## Technical documentation

Characteristics		References <sup>(1)</sup>
<b>Schneider Charge range</b>		
Schneider Charge Data sheet	EN	998-22833864
Schneider Charge Installation guide	EN / FR / DE / ES / IT	PKR9096301
Schneider Charge Commissioning guide	EN / FR / DE / ES / IT	PKR9545101
Anti-tripping module 1P - Installation guide	EN / FR / ES / IT	BQT5080501
Anti-tripping module 3P - Installation guide	EN / FR / DE / ES / IT	BQT5080401
<b>EVlink Pro AC range</b>		
Installation Guide <sup>(1)</sup>	EN / FR	NNZ1940301-00
Instruction Guide EVlink Pro AC Metal WM1CP <sup>(1)</sup>	EN / FR	JYT24399
Instruction Guide EVlink Pro AC Metal FS1CP <sup>(1)</sup>	EN / FR	JYT24398
Instruction Guide EVlink Pro AC Metal FS2CP <sup>(1)</sup>	EN / FR	JYT24397
EVlink Pro AC troubleshooting guide	EN	JYT6692101
Technical specifications OCPP connectivity guide	EN	GEX1969200
EVlink Pro AC spare parts replacement	EN	GEX2273501
EVlink Pro AC spare parts replacement for standards	EN	GEX4591201
Technical specifications MODBUS connectivity guide	EN	GEX1969300
EVlink Pro AC Preventive Maintenance guide	EN	GEX8681300
EVlink Pro AC Cybersecurity guide	EN	GEX5261101
Electrical diagram guide for EVlink Pro AC Metal	EN	GEX2008002
<b>EVlink Pro DC range</b>		
Installation Guide <sup>(1)</sup>	EN	GEX4300800
Owner Guide	EN	GEX4301000
Technical specifications OCPP connectivity guide	EN	DOCA0311
Cyber-security Guide	EN	DOCA0310
<b>EcoStruxure™ EV Charging Expert</b>		
Installation Guide	EN	DOCA0164
User Guide	EN	DOCA0163
Quick Start commissioning Guide	EN	EVSOLQSC001EN
<b>eMobility Services</b>		
<b>eMobility Services - Brochure</b>		
EVlink Warranty Extension	EN	998-21827492
EVlink Commissioning Service	EN	998-21950800_B
EcoStruxure EV Charging Expert Upgrade and Commissioning package	EN	998-22046477
<b>eMobility Services - Statement of work</b>		
Warranty Extension	EN	JYT9348100
Remote Commissioning	EN	PKR2869000
On-site commissioning for AC infrastructure	EN	GEX5781900
Service Plan for DC infrastructure	EN	DOCA0309
On-site commissioning for DC infrastructure	EN	DOCA0308

<sup>(1)</sup> Delivered with the product

(1) References to be defined and local availability to be checked by Schneider Electric front offices.







**Schneider Electric Industries SAS**

35, rue Joseph Monier  
CS 30323  
92506 Rueil Malmaison Cedex  
France

RCS Nanterre 542 048 574  
Capital social 2 268 274 220 €  
[www.se.com](http://www.se.com)

01/2024  
E-MOBILITY-EVL-CAT04\_EN

